



Panasonic

2.4GHz Digital Cordless Phone

Operating Instructions

Model No. **KX-TG2236S**

Pulse-or-tone dialing capability



Caller ID Compatible

PLEASE READ BEFORE USE AND SAVE.

Charge the battery for about 15 hours before initial use.

Panasonic World Wide Web address: <http://www.panasonic.com>
for customers in the USA or Puerto Rico

Preparation

Basic Operation

Advanced Operation

Useful Information

Thank you for purchasing your new Panasonic cordless telephone.

Please read IMPORTANT SAFETY INSTRUCTIONS on page 63 before use. Read and understand all instructions.

Caller ID and Call Waiting Service and Voice Mail Service, where available, are telephone company services. After subscribing to Caller ID, this phone will display a caller's name and phone number. Call Waiting Caller ID, which displays a second caller's name and phone number while the user is on the phone line with the first caller, requires a subscription to both Caller ID and Call Waiting Service. After subscribing to Voice Mail Service, this phone's VM indicator will flash when there are new messages left in the voice mail box at phone company.

Attach your purchase receipt here.

Energy Star:

As an ENERGY STAR® Partner, Panasonic has determined that this product meets the ENERGY STAR guidelines for energy efficiency. ENERGY STAR is a U.S. registered mark.



For your future reference

Serial No. _____
(found on the bottom of the unit)

Date of purchase _____

Name and address of dealer _____

Accessories (included) For extra orders, call 1-800-332-5368.

- AC Adaptor (p. 11)
Order No. PQLV1Z
(PQLV1)



one

- Telephone Line Cord
(p. 11)
Order No. PQJA10075Z



one

- Battery (p. 12, 57)
Order No.
N4HKGMA00001
(P-P511)

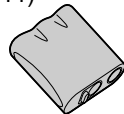

one

- Handset Cover
(p. 12, 57)
Order No.
PQKK10127Z1



one

- Wall Mounting
Adaptor (p. 54)
Order No.
PQKL10035Z3

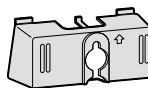

one

- Belt Clip (p. 56)
Order No.
PQKE10341Z1



one

For Best Performance

Battery Charge

A rechargeable Ni-Cd battery powers the handset. Charge the battery for about **15 hours** before initial use (p. 12).

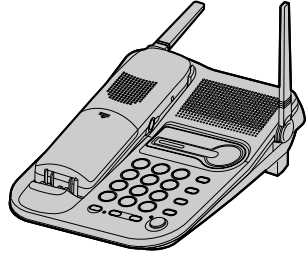

Base Unit Location/Noise

Calls are transmitted between the base unit and the handset using wireless radio waves. **For maximum distance and noise-free operation**, the recommended base unit location is:

Away from electrical appliances such as a TV, personal computer or another cordless phone.

In a **HIGH** and **CENTRAL** location with no obstructions such as walls.

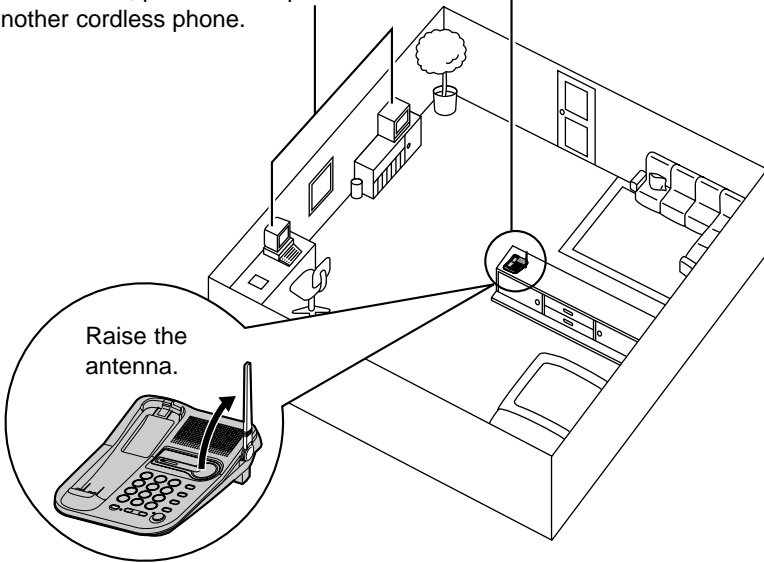

Note:

While using the handset:

- If you are near a microwave oven which is being used, noise may be heard from the receiver or the speaker. Move away from the microwave oven and closer to the base unit.
- If more than one cordless phone is being used and your handset is near another cordless phone's base unit, noise may be heard. Move away from the other cordless phone's base unit and closer to your base unit.

Contents

Preparation

Location of Controls	6
Display	8
Settings	11
Connections	11
Installing the Battery in the Handset	12
Battery Charge	12
Dialing Mode	14
Line Mode	15
Programmable Functions	16
Auto Talk Feature	17
Ringer Volume	18
Ringer Pattern	19
LCD Contrast	20

Basic Operation

Making Calls	21
Handset	21
Base Unit (Digital Duplex Speakerphone)	25
Answering Calls	27
Handset	27
Base Unit	27
Caller ID Service	28
Using the Caller List	29
Viewing the Caller List	29
Calling Back from the Caller List	31
Editing the Caller's Phone Number	32
The Caller ID Number Auto Edit Feature	33
Storing Caller List Information in the Directory	34
Erasing Caller List Information	35

Advanced Operation

Speed Dialer	36
Storing Phone Numbers	36
Dialing a Stored Number	37
Directory	38
Storing Names and Numbers	38
Entering Names and Symbols	40
Finding Stored Items	42
Dialing	43
Editing	44
Erasing	45

Intercom	46
Transferring a Call Using the Intercom	47
Voice Mail Service	48
Storing a Voice Mail Access Number	48
Setting the Voice Mail Tone	49
Listening to Voice Mail Messages	50
Special Features	51
Automatic Security Code Setting	51
Temporary Tone Dialing (For Rotary or Pulse Service Users)	51
Muting Your Conversation	51
For Call Waiting Service Users	52
How to Use the PAUSE Button (For Analog PBX Line/Long Distance Service Users)	52
FLASH Button	53

Useful Information

Wall Mounting	54
Belt Clip	56
Optional Headset	56
Battery Replacement	57
Adding Another Phone	58
Troubleshooting	59
Important Safety Instructions	63
FCC and Other Information	64
Specifications	67
Index	68
Warranty	69

Location of Controls

Base unit

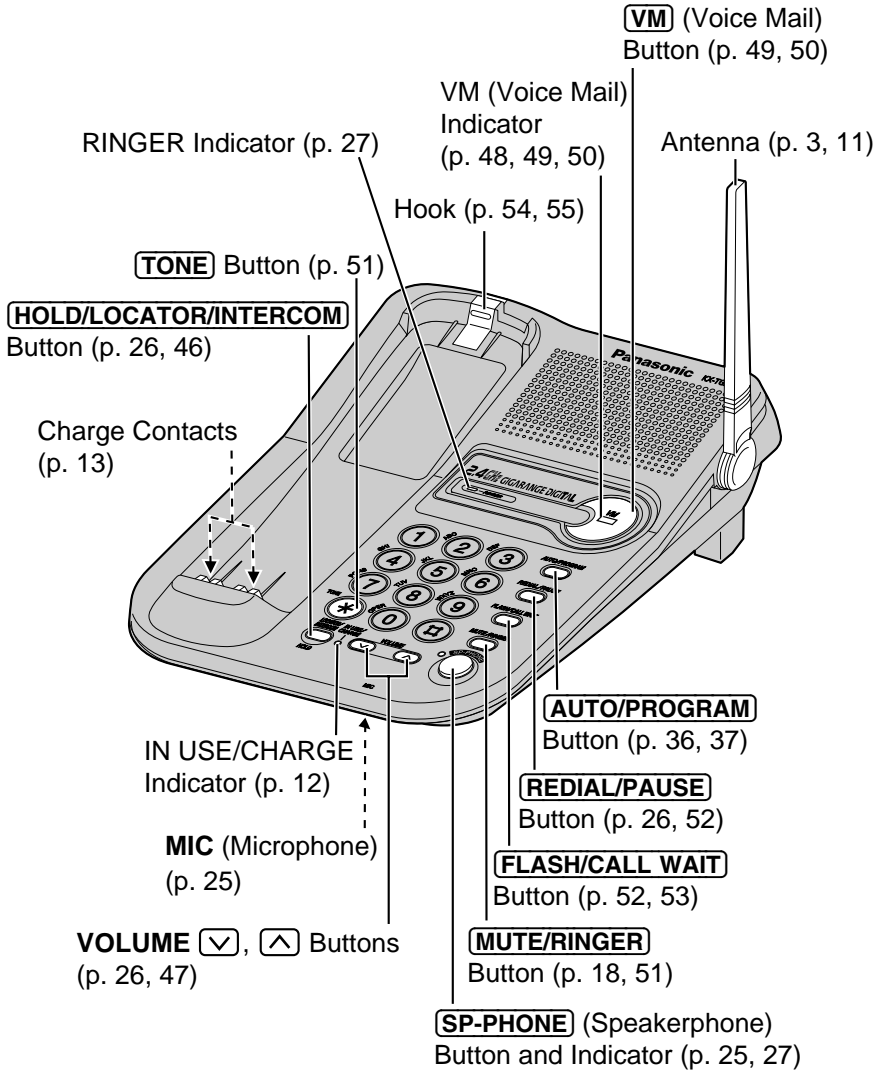

Handset

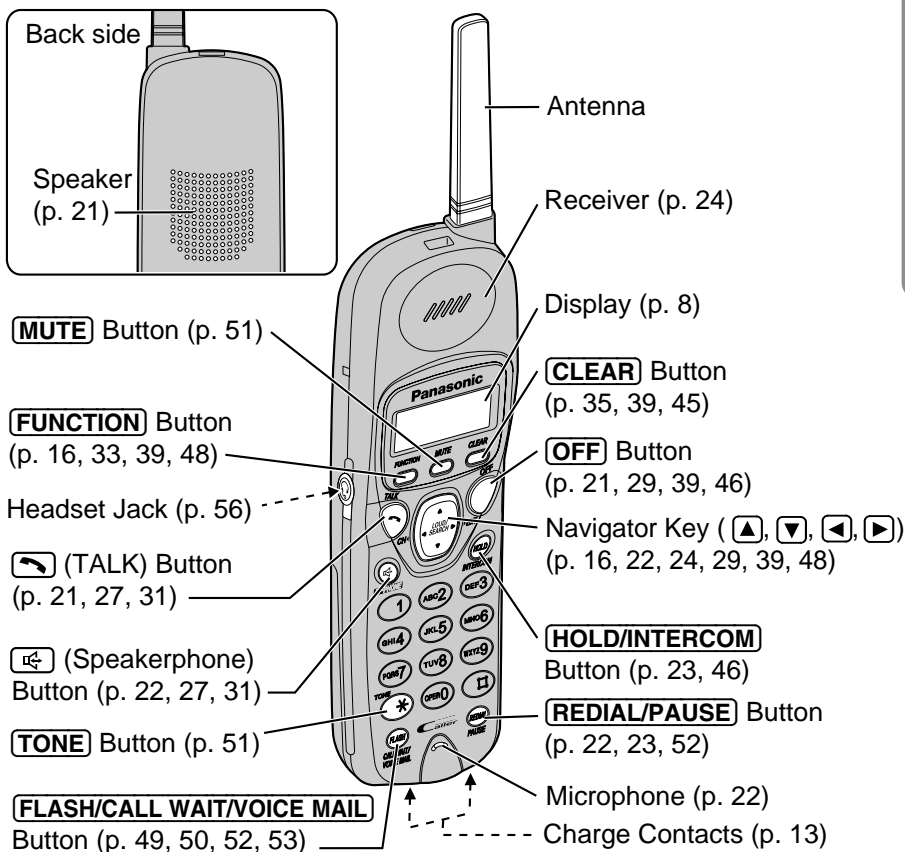

How to use the Navigator key

This key has four active areas that are indicated by arrows.

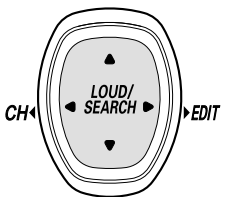

- Pressing the up or down arrow allows you to enter the Caller List and scroll through the function menu, the Caller List and the directory list. It is also used to adjust the handset ringer and receiver/speaker volumes.
- Pressing the right or left arrow allows you to enter the directory list and move the cursor when entering items. The right arrow is used to select or confirm your menu choices and to edit a phone number of the Caller List into one of 3 patterns. The left arrow is used to select a clearer channel.

Throughout this Operating Instructions, the navigator key is indicated by the arrows ▼, ▲, ◀ or ▶.

Display



The handset shows you instructions and information on the display. These display prompts are shown below.

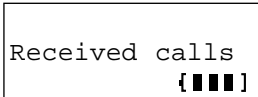

The battery needs to be charged. Place the handset on the base unit to charge the battery (p. 13).





(Handset on the base unit)

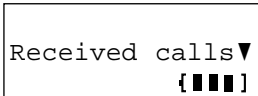

The display shows that you have received new calls (p. 29). To check the new calls, lift the handset and press  or .



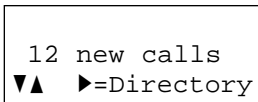

(Handset off the base unit)

The display shows that you have received new calls (p. 29). To check the new calls, press  or .



This display shows the number of new calls when  or  is pressed while the handset is off the base unit.

To search from the most recent call, press . To search from the oldest call, press  (p. 29). To go to the directory list, press  (Directory key).

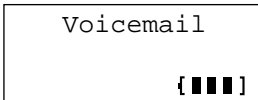

The display shows the voice mail message(s) is/are recorded (p. 50).

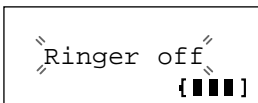

When the handset ringer volume is set to OFF (p. 18), "Ringer off" will flash for about 45 seconds after completing operations such as talk, viewing the Caller List or programming.

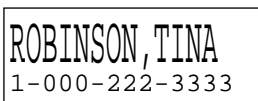

When a call is received, the display shows the caller's name and number after the first ring.



Talk
01-06-35 [■■■■]

During a conversation, the display shows the length of the call (ex. 1 hour, 6 minutes and 35 seconds). The battery strength is also displayed (p. 13).

No link to base
Place on cradle
and try again.

The handset has lost communication with the base unit. Place the handset on the base unit and try again.

SMITH, JACK
1-222-333-4444
11:20A JAN10 X3

This is a name from the Caller List. The display shows:
— the caller's name,
— the caller's number,
— the time and date of the last call (ex. Jan. 10, 11:20 AM), and
— the number of times called (ex. 3 times).

Ann
123-456-7890

This is a name from the directory. The stored name and phone number are displayed.

BROWN, NANCY
1-555-666-7777
----Waiting----

A second call is received during a conversation (p. 52).

Please lift up
and try again.

▼, ▲, ◀ or ▶ was pressed while the handset was on the base unit. Lift the handset and press the button again.

Not available

While the base unit was in use, ▼ or ▲ was pressed to search the Caller List/directory list, ▶ was pressed to select an option or **HOLD/INTERCOM** was pressed.

Display

Directory full

When trying to store an item or Caller List information in the directory, the directory memory is full (p. 34, 39).

Save error

While programming procedure, the handset has lost communication with the base unit. Move closer to the base unit and try again.

Settings



Connections

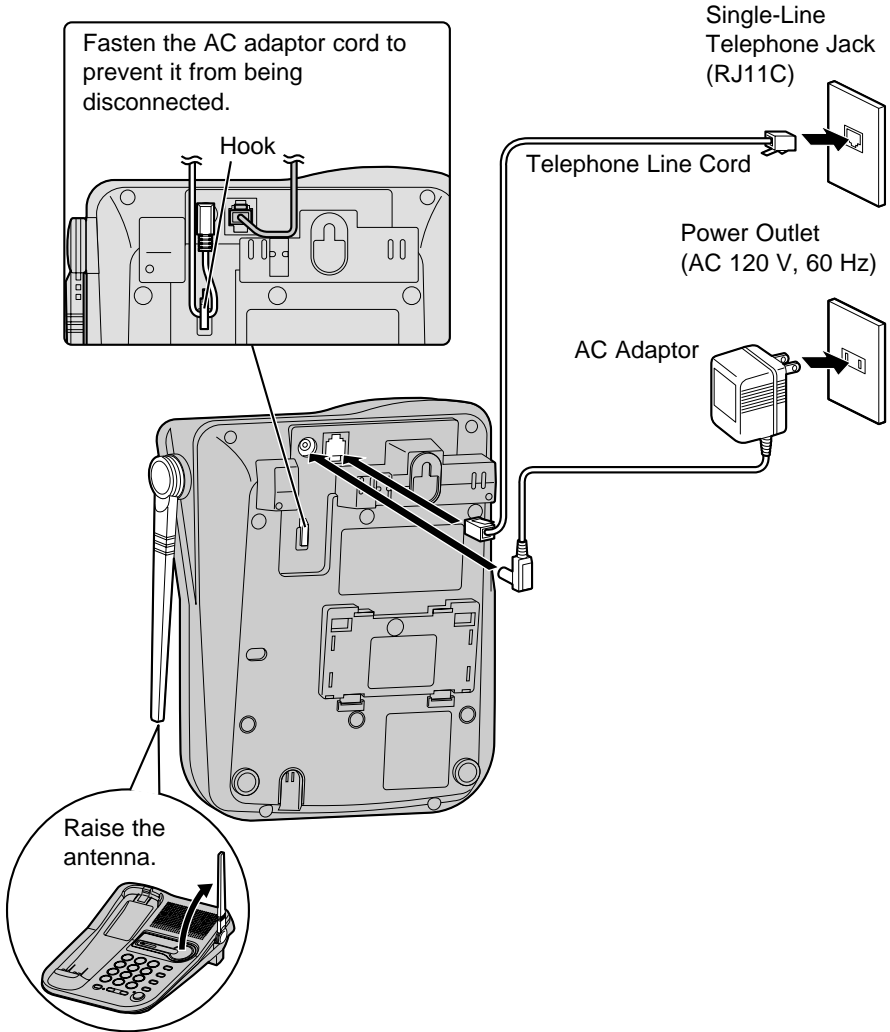

- USE ONLY WITH Panasonic AC ADAPTOR PQLV1 (Order No. PQLV1Z).
- The AC adaptor must remain connected at all times. (It is normal for the adaptor to feel warm during use.)
- To connect a standard telephone on the same line, see page 58.
- If your unit is connected to a PBX which does not support Caller ID services, you cannot access those services.

Installing the Battery in the Handset

Insert the battery into the handset as shown, matching the correct polarity (①). Press the battery down until it places into the compartment (②). When finished, close the cover.

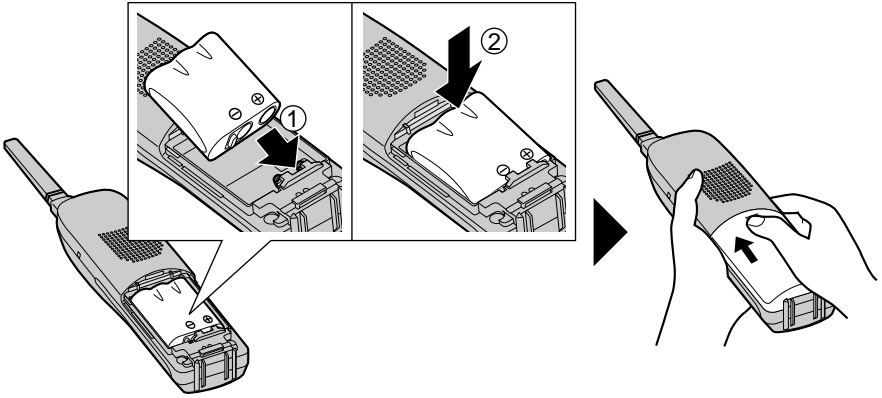

Battery Charge

Place the handset on the base unit and charge for about **15 hours** before initial use.

- The IN USE/CHARGE indicator lights and a beep sounds.

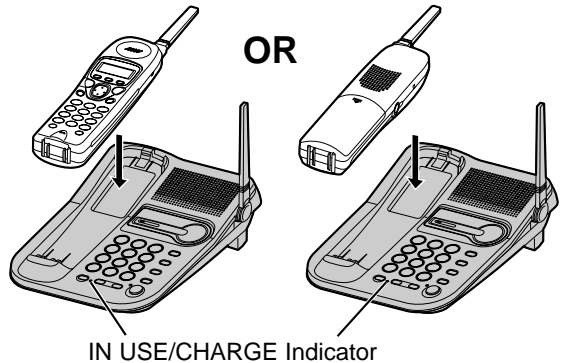



Battery strength

You can check the battery strength on the handset display. The battery strength is as shown in the chart below.

Display prompt	Battery strength
{ ■■■ }	Fully charged
{ ■■ }	Medium
{ ■ }	Low
⚡ { ■ } ⚡ (flashing)	Needs to be recharged.

Recharge

Recharge the battery when:

- “Recharge” is displayed on the handset,
- “{ ■ }” flashes on the display, or
- the handset beeps intermittently while it is in use.

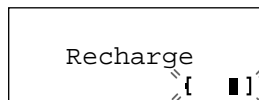

- If you DO NOT recharge the handset battery for more than 15 minutes, the display will keep indicating “Recharge” and/or “{ ■ }” will continue to flash.

Battery information

After your Panasonic battery is fully charged (p. 12):

Operation	Operating time
While in use (TALK)	Up to 5 hours
While not in use (Standby)	Up to 11 days

- The battery operating time may be shortened depending on usage conditions, such as viewing the Caller ID Caller List or directory list, and ambient temperature.
- Clean the handset and the base unit charge contacts with a soft, dry cloth once a month. Clean more often if the unit is subject to grease, dust or high humidity.** Otherwise the battery may not charge properly.
- If the battery is fully charged, you do not have to place the handset on the base unit until “Recharge” is displayed and/or “{ ■ }” flashes. This will maximize the battery life.
- The battery cannot be overcharged.

➡ Settings

Dialing Mode

If you have touch tone service, set to “Tone”. If rotary or pulse service is used, set to “Pulse”. Your phone comes from the factory set to “Tone”.

Make sure the unit is not being used and the handset is lifted off the base unit.

1 Press **FUNCTION**.

```
-----
▶Save directory
Ringer volume
```

2 Scroll to “Program” by pressing **▼** or **▲**.

```
Ringer pattern
▶Program
-----
```

3 Press **▶**.

```
-----
▶Set flash time
Save mailbox#
```

4 Scroll to “Set dial mode” by pressing **▼** or **▲**.

```
Set line mode
▶Set dial mode
Talk switching
```

5 Press **▶**.

```
Dial mode
           :Tone
▼▲         ▶=Save
```

6 Select “Pulse” or “Tone” by pressing **▼** or **▲**.

```
Dial mode
           :Pulse
▼▲         ▶=Save
```

7 Press **▶** (Save key).

- A beep sounds.
- To exit the programming mode, press **OFF**.

```
Dial mode
           :Pulse
```

•You can exit the programming mode any time by pressing **OFF**.

Line Mode

If the line is connected to a low voltage system such as a PBX, set to "B". Your phone comes from the factory set to "A".

Make sure the unit is not being used and the handset is lifted off the base unit.

- 1 Press **FUNCTION**.

 ▶Save directory
 Ringer volume
- 2 Scroll to "Program" by pressing **▼** or **▲**.

Ringer pattern
 ▶Program

- 3 Press **▶**.

 ▶Set flash time
 Save mailbox#
- 4 Scroll to "Set line mode" by pressing **▼** or **▲**.

Voicemail tone
 ▶Set line mode
 Set dial mode
- 5 Press **▶**.

Line mode
 :A
▼▲ ▶=Save
- 6 Select "B" or "A" by pressing **▼** or **▲**.

Line mode
 :B
▼▲ ▶=Save
- 7 Press **▶** (Save key).

Line mode
 :B

 - A beep sounds.
 - To exit the programming mode, press **OFF**.

•You can exit the programming mode any time by pressing **OFF**.

Programmable Functions

You can program the following function items **using the handset near the base unit**. The display shows the programming instructions. See the corresponding pages for function details.

Make sure the unit is not being used and the handset is lifted off the base unit.

Press **[FUNCTION]**.

<Function menu>*

▶ Save directory..... To store an item in the directory (p. 39).
Ringer volume..... To select the ringer volume (p. 18).
Ringer pattern..... To select the ringer pattern (p. 19).
Program

Press **[▶]**.

<Function menu>*

▶ Set flash time..... To select the flash time (p. 53).
Save mailbox#..... To store a voice mail access number (p. 48).
Voicemail tone..... To set the voice mail tone (p. 49).
Set line mode..... To select the line mode (p. 15).
Set dial mode..... To select the dialing mode (p. 14).
Talk switching..... To set the Auto Talk feature (p. 17).
CallerID edit..... To set the Caller ID Number Auto Edit feature (p. 33).
LCD contrast..... To select the LCD contrast (p. 20).

During programming:

*To select a desired function item, scroll through the items by pressing **[▼]** or **[▲]**. Then press **[▶]** to go to the next step.

- “-----” indicates the beginning or end of the function menu.
- You can exit the programming mode any time by pressing **[OFF]**.
- If you do not press any buttons for 60 seconds, the unit will exit the programming mode.
- If the handset has lost communication with the base unit, 3 beeps sound and “No link to base Place on cradle and try again.” is displayed.



Auto Talk Feature

The Auto Talk feature allows you to answer a call by lifting the handset off the base unit without pressing or . If you want to use this feature, turn the feature ON by programming. Your phone comes from the factory set to OFF.

Make sure the unit is not being used and the handset is lifted off the base unit.

1 Press **FUNCTION**.

2 Scroll to "Program" by pressing or .

```
Ringer pattern
▶Program
-----
```

3 Press .

4 Scroll to "Talk switching" by pressing or .

```
Set dial mode
▶Talk switching
  CallerID edit
```

5 Press .

```
Auto talk
                                :Off
▼▲                               ▶=Save
```

6 Select "On" or "Off" by pressing or .

```
Auto talk
                                :On
▼▲                               ▶=Save
```

7 Press (Save key).

- A beep sounds.
- To exit the programming mode, press **OFF**.

```
Auto talk
                                :On
```

- You can exit the programming mode any time by pressing **OFF**.
- In order to view Caller ID information after you lift up the handset to answer a call, leave the Auto Talk feature OFF.

➡ Programmable Functions

Ringer Volume

You can program the handset or base unit ringer volume to HIGH, LOW or OFF. If set to OFF, the handset or base unit will not ring. Your phone comes from the factory set to HIGH.

Make sure the unit is not being used and the handset is lifted off the base unit.

With the handset

- 1 Press **FUNCTION**.
- 2 Scroll to "Ringer volume" by pressing **▼** or **▲**.
- 3 Press **▶**.
- 4 Select the desired volume by pressing **▼** or **▲**.
 - Each time you press **▼** or **▲**, the volume will change and ring.
 - If you set to OFF, the unit will not ring.
- 5 Press **▶** (Save key).
 - A beep sounds.

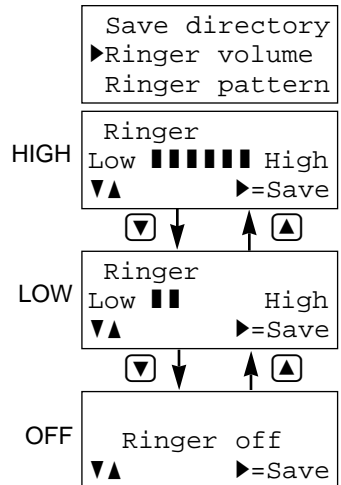

- You can exit the programming mode any time by pressing **OFF**.
- When you replace the battery, the selected ringer volume setting will return to the factory set (HIGH). Reprogram if necessary.

With the base unit

To select HIGH (preset) or LOW, press **MUTE/RINGER**.

- Each time you press the button, the ringer volume will change and ring.

To turn the ringer OFF, press and hold **MUTE/RINGER** until 2 beeps sound.

To turn the ringer ON, press **MUTE/RINGER**.

- The ringer will sound at the HIGH level.



Ringer Pattern

You can select the handset or the base unit ringer pattern out of 6 patterns. When an incoming call is being received, the unit rings in the selected pattern.

Your phone comes from the factory set to 1.

Make sure the unit is not being used and the handset is lifted off the base unit.

With the handset

1 Press **FUNCTION**.

2 Scroll to "Ringer pattern" by pressing **▼** or **▲**.

```
Ringer volume
▶Ringer pattern
Program
```

3 Press **▶**.
•The current setting is displayed.

```
Ringer pattern
:1
▼▲ ▶=Save
```

4 Select the desired ringer pattern by pressing **▼** or **▲**.
•Each time you press **▼** or **▲**, the ringer pattern will change and ring.
•You can also select the ringer pattern by pressing dialing buttons **1** to **6**.
•If you set the ringer volume to OFF, the handset will not ring (p. 18).

```
Ringer pattern
:3
▼▲ ▶=Save
```

5 Press **▶** (Save key).
•A beep sounds.
•To exit the programming mode, press **OFF**.

```
Ringer pattern
:3
```

•You can exit the programming mode any time by pressing **OFF**.

With the base unit

1 Press **MUTE/RINGER**.
•The base unit rings in the current setting.

2 Within 5 seconds, select the desired ringer pattern by pressing dialing buttons **1** to **6**.
•Each time you press the buttons, the ringer pattern will change and ring.

➔ Programmable Functions

LCD Contrast

You can program the handset LCD contrast (5 levels). To make the handset display clearer, set to high level. Your phone comes from the factory set to level 3.

Make sure the unit is not being used and the handset is lifted off the base unit.

1 Press **FUNCTION**.

2 Scroll to "Program" by pressing ▼ or ▲.

```
Ringer pattern
▶Program
-----
```

3 Press ▶.

4 Scroll to "LCD contrast" by pressing ▼ or ▲.

```
CallerID edit
▶LCD contrast
-----
```

5 Press ▶.

```
LCD contrast
Low ■■■ High
▼▲ ▶=Save
```

6 Select the desired contrast by pressing ▼ or ▲.

- Each time you press ▼ or ▲, the LCD contrast will change.

7 Press ▶ (Save key).

- A beep sounds.
- To exit the programming mode, press **OFF**.

```
LCD contrast
Low ■ High
```

- You can exit the programming mode any time by pressing **OFF**.

Making Calls



Handset

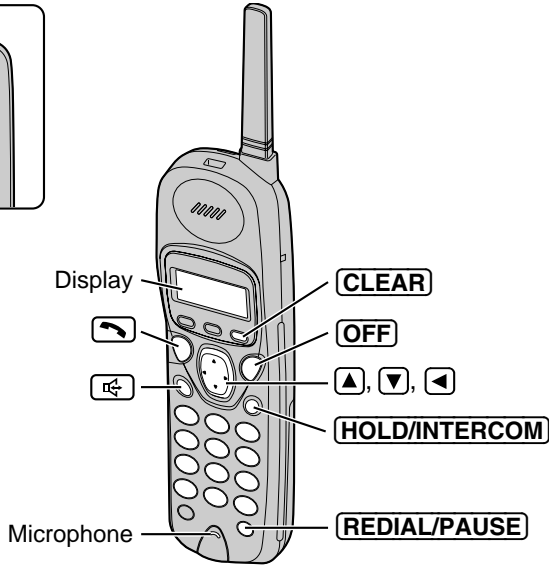
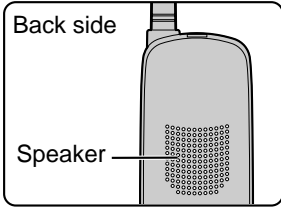

1 Press

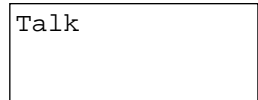

2 Dial a phone number.

- The dialed number is displayed.
- After a few seconds, the display will show the length of the call and the battery strength.

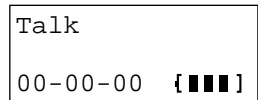
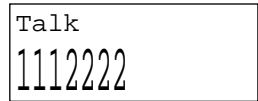

3 To hang up, press **OFF** or place the handset on the base unit.

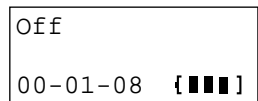

- If the handset has lost communication with the base unit, 3 beeps sound and “No link to base Place on cradle and try again.” is displayed.

➔ Making Calls

To have a hands-free phone conversation (Using Digital Duplex Speakerphone)

1 Press .

SP-phone

2 Dial a phone number.

- The dialed number is displayed.
- After a few seconds, the display will show the length of the call and the battery strength.

SP-phone

11112222

SP-phone

00-00-00 [■■■■]

3 When the other party answers, talk into the microphone.

4 To hang up, press **OFF** or place the handset on the base unit.





Off

00-01-08 [■■■■]

- If the handset has lost communication with the base unit, 3 beeps sound and “No link to base Place on cradle and try again.” is displayed.

Hands-free Digital Duplex Speakerphone



For best performance, please note the following:

- Talk alternately with the caller in a quiet room.
- If the other party has difficulty hearing you, press  to decrease the speaker volume.
- If the other party's voice from the speaker cuts in/out during a conversation, press  to decrease the speaker volume.
- While talking using , you can switch to the hands-free phone conversation by pressing . To switch back to the receiver, press .

If noise interferes with the conversation

Press  to select a clearer channel in the talk, speakerphone or intercom mode, or move closer to the base unit.

To redial the last number dialed on the handset

Press  or  and press **REDIAL/PAUSE**.



To dial after confirming the entered number

- 1 Dial a phone number.
 - If you misdial, press **CLEAR**. One digit is erased. Dial the correct phone number.

3334444

- 2 Press .
OR
To have a hands-free phone conversation, press , and when the other party answers, talk into the microphone.
 - After a few seconds, the display will show the length of the call and the battery strength.

Ex. was pressed.

Talk
3334444

Talk
00-00-00 [||||]

- 3 To hang up, press **OFF** or place the handset on the base unit.

To redial using the redial list (Memory Redial)

The last 5 phone numbers dialed with the handset are stored in the redial list.

1. Press **REDIAL/PAUSE**.
 - The last number dialed is displayed.
2. Scroll to the desired number by pressing or .
 - You can also scroll through the list by pressing **REDIAL/PAUSE**.
 - To exit the list, press **OFF**.
3. Press or .

333-4444
▼▲Redial list

- To erase an item, repeat steps 1 and 2, and press **CLEAR**.
- If "No items stored" is displayed, the list is empty.

To put a call on hold

Press **HOLD/INTERCOM**.

- "Hold" is displayed.
- If you put a call on hold for more than 6 minutes, an alarm tone will sound. The call will be disconnected after a total of 10 minutes.

Hold
00-00-08 [||||]

To release the hold

From the handset, lift the handset, or press or .
From the base unit, press **SP-PHONE**.

- If another phone is connected on the same line (p. 58), you can also release the hold by lifting its handset.

➔ Making Calls

To adjust the receiver volume (HIGH, MEDIUM or LOW) or speaker volume (6 levels) while talking

To increase, press ▲.

To decrease, press ▼.

- The display will return to the length of the call.

While using 📞

- Each time you press ▼ or ▲, the volume level will change among 3 levels (HIGH, MEDIUM or LOW). Your phone comes from the factory set to level MEDIUM.

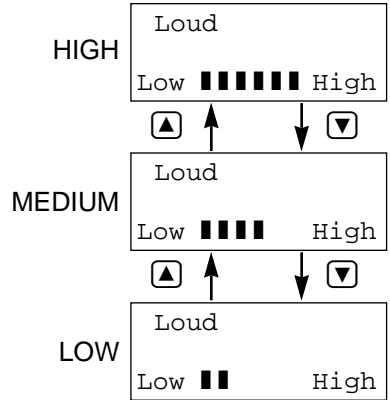

While using 📞

- Each time you press ▼ or ▲, the volume level will change among 6 levels. Your phone comes from the factory set to level 3.

Ex. Speaker volume:
level 6

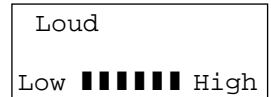

- When you replace the battery, the selected receiver/speaker volume setting will return to the factory set. Reprogram if necessary.

Lighted handset keypad

The handset dialing buttons will light when you press a button or lift the handset off the base unit. They flash when a call is received with the handset off the base unit.

The lights will go out a few seconds after pressing a button, lifting the handset, answering a call, hanging up a call, leaving the programming mode or ending the intercom.

Backlit LCD display

The lighted handset display will stay on for a few seconds after pressing a handset button, lifting the handset off the base unit, hanging up a call, leaving the programming mode or ending the intercom.



Base Unit (Digital Duplex Speakerphone)

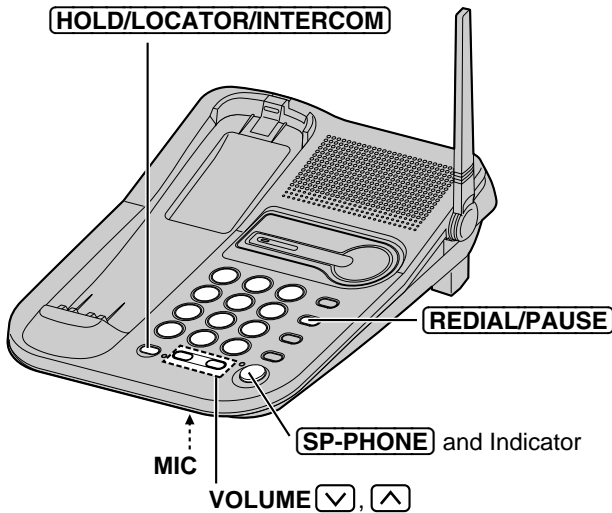



- 1 Press **SP-PHONE**.
 - The SP-PHONE indicator lights.
 - 2 Dial a phone number.
 - 3 When the other party answers, talk into the **MIC** (microphone).
 - 4 To hang up, press **SP-PHONE**.
 - The indicator light goes out.
- To switch to the handset while using the base unit speakerphone:
 - If the handset is off the base unit, press or .
 - If on the base unit, just lift up.
 - During a call using the handset, the call can be switched to the base unit by pressing **SP-PHONE** on the base unit.

➡ Making Calls

Hands-free Digital Duplex Speakerphone

For best performance, please note the following:

- Talk alternately with the caller in a quiet room.
- If the other party has difficulty hearing you, press **VOLUME**  to decrease the speaker volume.
- If the other party's voice from the speaker cuts in/out during a conversation, press **VOLUME**  to decrease the speaker volume.

To adjust the speaker volume (8 levels) while talking

To increase, press **VOLUME** .

To decrease, press **VOLUME** .

To redial the last number dialed on the base unit

Press **SP-PHONE** and press **REDIAL/PAUSE**.



To put a call on hold

Press **HOLD/LOCATOR/INTERCOM**.

- The SP-PHONE indicator flashes.
- If you put a call on hold for more than 6 minutes, an alarm tone will sound. The call will be disconnected after a total of 10 minutes.

To release the hold

From the base unit, press **SP-PHONE**.

From the handset, press  or , or lift the handset off the base unit.

- If another phone is connected on the same line (p. 58), you can also release the hold by lifting its handset.

Answering Calls

When a call is received, the unit rings and “Incoming call” is displayed and the RINGER indicator on the base unit flashes. If you subscribe to a Caller ID service, the calling party information will be displayed after the first ring (p. 28).

In order to view the Caller ID information, please wait until the second ring to answer a call.

Handset



If the handset is off the base unit;

Press .

•You can also answer a call by pressing any dialing button **0** to **9**, ***** or **#** (—Any Key Talk).

OR

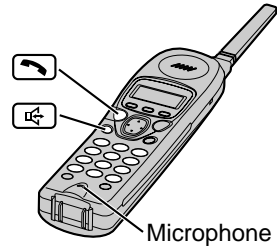

Press , and when the other party answers, talk into the microphone.

•You can select the ringer volume while a call is being received. Press  or  while the handset is just ringing. To set to OFF, press and hold .



Auto Talk

If you set the Auto Talk feature to ON (p. 17), you can answer a call by lifting the handset off the base unit without pressing

 or .

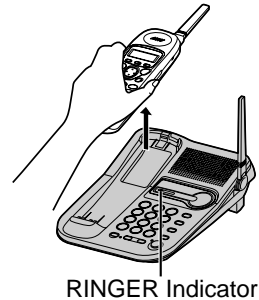

Base Unit

1 Press **SP-PHONE**.
•The SP-PHONE indicator lights.

2 Talk into the **MIC**.

3 To hang up, press **SP-PHONE**.
•The indicator light goes out.



•You can select the ringer volume while a call is being received. Press **MUTE/RINGER** while the base unit is just ringing. To set to OFF, press and hold **MUTE/RINGER**.

•When the handset and base unit ringer volumes are set to OFF, they will not ring (p. 18).

Caller ID Service

This unit is compatible with a Caller ID service offered by your telephone company. If you subscribe to a Caller ID service, the calling party's information will be shown on the handset after the first ring.

The unit can record information of up to 30 different callers, including the time and date received and the number of times called, in the Caller List. The Caller List information is sorted by the most recent to the oldest call. When the 31st call is received, the first call is deleted.

Using the list, you can automatically call back a caller. You can store the callers' names and numbers from the Caller List into the directory.

If you subscribe to both Caller ID and Call Waiting services, when a second call is received while talking, the new caller's name and phone number will be displayed (p. 52).

How caller information is displayed when a call is received

The handset display shows the caller's name and phone number after the first ring.

After you answer the call, the display will show the length of the call and the battery strength.

ROBINSON, TINA
1-000-222-3333

Talk
00-00-00 [■■■■]

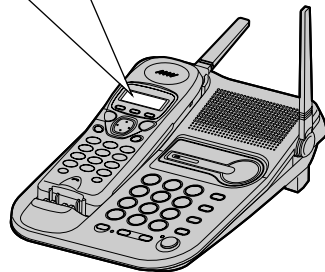

- Caller information cannot be displayed in the following cases:
 - If the caller dialed from an area which does not provide a Caller ID service, the display will show "Out of area".
 - If the caller has requested not to display his/her information, the display will show "Private caller".
- If your unit is connected to a PBX which does not support Caller ID services, you cannot access those services.
- The name display service may not be available in some areas. For further information, please contact your telephone company.

Using the Caller List



If you have received new calls, "Received calls" will be displayed while the unit is not in use.

Handset on the base unit

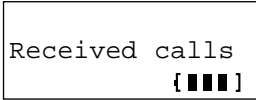

Handset off the base unit

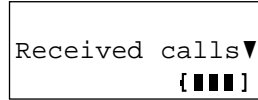

Viewing the Caller List

To check who has called, follow the steps below.

Make sure the unit is not being used and the handset is lifted off the base unit.

- 1 Press or to enter the Caller List.
 - The display will show, for example, the following.

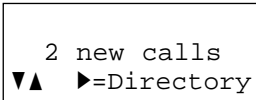

- You can go to the directory list by pressing (p. 42).

- 2 To search from the most recent call, press .
To search from the oldest call, press .
 - To scroll between callers, press or .

- 3 To exit the list, press **OFF**.

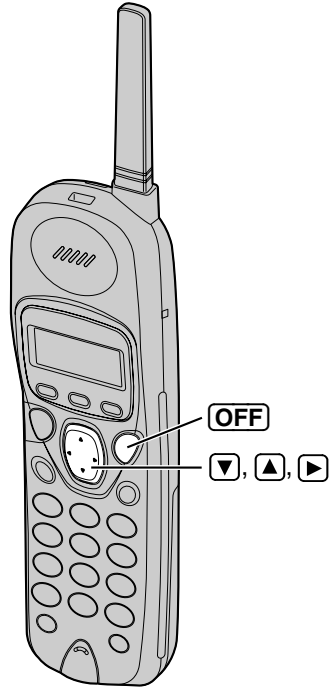

- Once new calls have been checked, "√" will be added.
- If "No items stored" is displayed in step 1, the Caller List is empty.
- If more than one call is received from the same caller, the date and time of the most recent call will be recorded. If the same caller calls again, the call entry with "√" will be deleted.
- If you do not press any buttons for 60 seconds, the unit will exit the Caller List.
- After viewing all of the new call entries, "Received calls" will disappear.

➔ Using the Caller List

Ex. When you search from the most recent call:

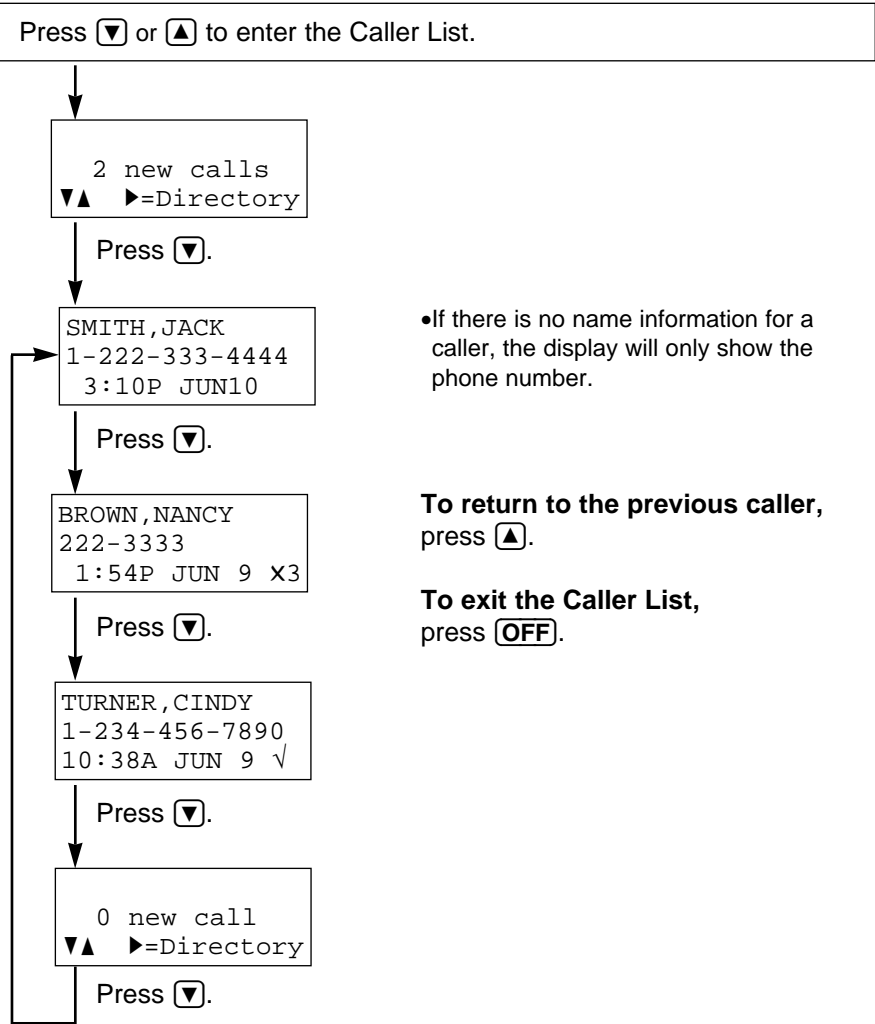

Display meaning:

- ✓ : You have checked this caller information, answered the call or called back the caller.
- x2-x9 : The number of times the same caller called (up to 9). After checking, “x2” – “x9” will be replaced with “✓”.



Calling Back from the Caller List

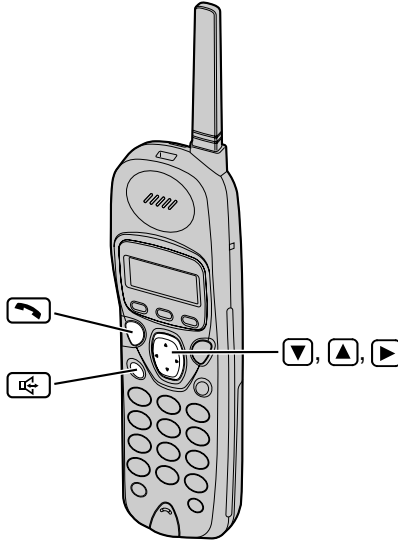

1 Press or to enter the Caller List.

3 new calls
 =Directory

2 Scroll to the desired caller by pressing or .

TURNER, CINDY
1-234-456-7890
11:20A JAN12 X3

3 Press or .
•The displayed phone number is dialed automatically.

Ex. was pressed.

Talk
12344567890

- In some cases, you may have to edit the number before dialing (p. 32). (Ex. You may have to delete “1” and the area code.)
- If a phone number is not displayed in the caller information, you cannot call back that caller.

➔ Using the Caller List



Editing the Caller's Phone Number

You can edit a phone number into one of 3 patterns (see below ①, ②, and ③ on this page) to call back or store it into the directory.



The Caller ID Number Auto Edit Feature (p. 33)

This feature will allow the unit to edit a Caller ID number into one of 3 patterns you desired for you automatically in the Caller List. For detail and activation please see page 33.

Make sure the unit is not being used and the handset is lifted off the base unit.

1 Press  or  to enter the Caller List.

5 new calls
▼▲ ▶=Directory

2 Scroll to the desired caller by pressing  or , and press .

PARKER, FRED
1-234-321-5555
11:20A JAN12 ✓

▶Edit
Save directory
▼▲ ▶=Yes

3 Press  (Yes key) at "Edit".

PARKER, FRED
1-234-321-5555
▼=Next ▶=Edit

4 Press  (Edit key) to select a pattern.

- Each time you press , the number is rearranged into one of 3 patterns.

① (7 digit pattern)

① 321-5555
▼=Next ▶=Edit

② - (10 digit pattern)

② 234-321-5555
▼=Next ▶=Edit

③ 1- - (11 digit pattern)

③ 1-234-321-5555
▼=Next ▶=Edit

- The order in which patterns ①-③ are displayed depends on how the telephone number is displayed in step 3.

5 After editing the number, you can continue with calling back or storing procedures.

To call back, press  or  (p. 31).

To store the number in the directory, press  (Next key). Follow the instructions on the display (p. 34). (If the caller has no name information, see page 34, from step 3.)



The Caller ID Number Auto Edit Feature

There are 3 patterns of phone number (a, b, and c on page 32). This feature allows your phone to automatically edit an in-coming Caller ID number into one pattern you preferred, and display the Caller ID number with that pattern on the handset automatically.

After this feature is activated, Caller ID numbers coming from considered area codes (201, for example), from which the Caller ID numbers have been chosen to follow the desired pattern (7 digit pattern, for example), will be automatically edited from other patterns (11 digit pattern, for example) into the same pattern you have previously selected (which is 7 digit pattern, in the example).

Up to 4 area codes are allowed for this feature for pattern a and b (p. 32).

To activate this feature, you must 1) set this feature to turn on, and 2) make an out-going call from Caller List (p. 31) with a number which has one of 3 patterns that you have edited with considered area code, and that you prefer to be followed by future Caller ID numbers, so that in the future all the Caller ID numbers coming from the same area code will be displayed in the same pattern.

The Caller ID number Auto Edit feature is preset to ON at factory.

•If you fail to reach your destination when making the call, the phone number you dialed might have an incorrect pattern, please edit the phone number with another pattern (p. 32).

For example, if you move to another area, you may need to turn this feature to OFF to erase previously edited area codes. Then, if still need, you may activate this feature again.

Make sure the unit is not being used and the handset is lifted off the base unit.

1. Press **FUNCTION**.
2. Scroll to "Program" by pressing or and press .
3. Scroll to "CallerID edit" by pressing or .
4. Press .
5. Select "On" or "Off" by pressing or .
6. Press (Save key).
 - A beep sounds.
 - To exit the programming mode, press **OFF**.

Ringer pattern
▶Program



Talk switching
▶CallerID edit
LCD contrast

•When the feature is set to OFF, the unit will still be able to display Caller ID, like regular Caller ID telephone, but the in-coming Caller ID number will not be edited by pattern and by area codes.



➡ Using the Caller List

Storing Caller List Information in the Directory

You can store phone numbers that are in the Caller List into the directory. **Make sure the unit is not being used and the handset is lifted off the base unit.**

1 Press  or  to enter the Caller List.



```
10 new calls
▼▲ ▶=Directory
```

2 Scroll to the caller you want to store in the directory by pressing  or , and press .

```
TURNER, CINDY
1-234-456-7890
11:20A JAN12 X3
```

•If the number requires editing, see page 32.

```
▶Edit
Save directory
▼▲ ▶=Yes
```

3 Scroll to “Save directory” by pressing  or , and press .

```
Edit
▶Save directory
▼▲ ▶=Yes
```



•A beep sounds.

•To continue storing other items, repeat from step 2.



•To exit the programming mode, press **OFF**.

```
TURNER, CINDY
1-234-456-7890
```

If there is no name information for the caller, “Enter name” will be displayed.

a) If a name is not required, press  (Next key) and press  (Save key).

```
Enter name
█
◀▶ ▼=Next
```

b) If a name is required, enter the name (p. 40). When finished, press  (Next key) and press  (Save key).

```
Enter name
CINDY TURNER
◀▶ ▼=Next
```

•A beep sounds.

•To continue storing other items, repeat from step 2.

•To exit the programming mode, press **OFF**.

```
CINDY TURNER
1-234-456-7890
```

•You can exit the programming mode any time by pressing **OFF**.

•If the display shows “Directory full” in step 3, press **OFF** to exit the list. To erase other stored items from the directory, see page 45.

•You cannot store caller information in the directory if a phone number is not displayed.

•If an alarm tone sounds in step 3, the item cannot be stored in the directory. Place the handset on the base unit and try again from step 1.

Erasing Caller List Information

After checking the Caller List, you can erase some or all of the entries.

Make sure the unit is not being used and the handset is lifted off the base unit.

To erase a specific caller from the Caller List

1 Press **▼** or **▲** to enter the Caller List.

10 new calls
▼▲ ▶=Directory

2 Scroll to the caller you want to erase from the Caller List by pressing **▼** or **▲**.

REAGAN, TOM
1-888-777-6666
12:20A JAN12 ✓

3 Press **CLEAR**.

- A beep sounds and the information is erased.
- To erase other items, repeat from step 2.
- To exit the Caller List, press **OFF**.

Clear

To erase all entries in the Caller List

Before erasing all entries, make sure that “0 new call” is displayed.

1 Press **▼** or **▲** to enter the Caller List.

0 new call
▼▲ ▶=Directory

2 Press **CLEAR**.

▶Exit
All clear
▼▲ ▶=Yes

3 Select “All clear” by pressing **▼** or **▲**.

Exit
▶All clear
▼▲ ▶=Yes

4 Press **▶** (Yes key) or **CLEAR**.

- A beep sounds and all entries are erased.
- The handset will exit the Caller List.

All clear

Speed Dialer

Storing Phone Numbers

You can store up to 10 phone numbers in the base unit. The dialing buttons (0 to 9) function as memory stations.

Make sure the unit is not being used.

- 1 Press **AUTO/PROGRAM**.
 - The IN USE/CHARGE indicator flashes.

- 2 Enter a phone number up to 22 digits.
 - If you misdial, press **AUTO/PROGRAM** twice to end storing, and start again from step 1.

- 3 Press **AUTO/PROGRAM**.

- 4 Press a memory station number (0 to 9).
 - A beep sounds.
 - To store other numbers, repeat steps 1 through 4.

Memory Station Numbers

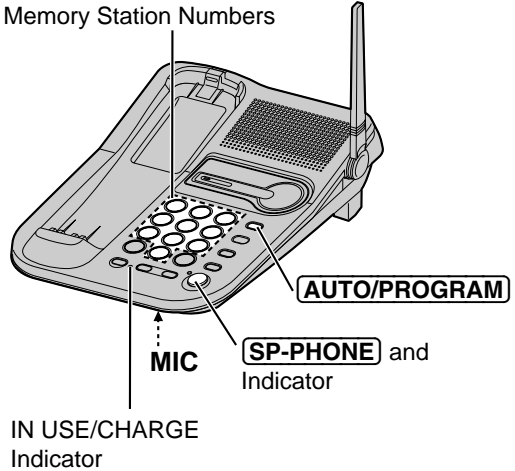

- If a pause is required for dialing, press **REDIAL/PAUSE** where needed. Pressing **REDIAL/PAUSE** counts as one digit (p. 52).

To erase a stored number

Press **AUTO/PROGRAM** twice, and then press the memory station number (0 to 9) for the phone number to be erased.

Dialing a Stored Number

- 1 Press **SP-PHONE**.
 - The SP-PHONE indicator lights.
 - 2 Press **AUTO/PROGRAM**.
 - 3 Press a memory station number (**0** to **9**).
 - The stored number is dialed.
- Numbers stored in the base unit can only be dialed from the base unit.

Directory

You can store up to 50 names and phone numbers in the directory using the handset. All directory items are sorted by the first word in alphabetical order. Using the directory, you can make a call by selecting a name on the handset display.

Storing Names and Numbers

Make sure the unit is not being used and the handset is lifted off the base unit.

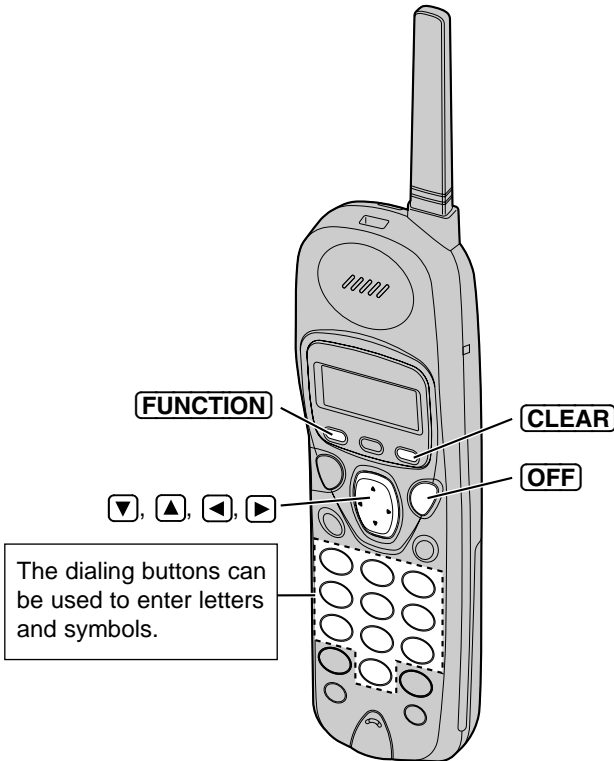



1 Press **FUNCTION**.

```
-----
▶Save directory
  Ringer volume
```

2 Press **▶** at “Save directory”.
•The display shows the number of stored items in the directory.

```
Directory=
  20 items
```

3 Enter a name, up to 15 characters with the dialing buttons, **◀** or **▶**.
•See the steps for entering names and symbols (p. 40).
•If a name is not required, press **▼** (Next key) and go to step 5.

```
Enter name
█
◀▶                ▼=Next
```

```
Enter name
Tom Jones
◀▶                ▼=Next
```

4 Press **▼** (Next key).

```
Enter phone no.

```

5 Enter a phone number, up to 22 digits.
•Each time you press **CLEAR**, a digit is erased. To erase all of the digits, press and hold **CLEAR**.

```
0987654321 █
◀▶                ▼=Next
```

6 Press **▼** (Next key).
•If you want to change the storing name or number, press **▲** (Edit key) repeatedly to reach the desired display and change it.

```
Tom Jones
098-765-4321
▲=Edit    ▶=Save
```

7 Press **▶** (Save key).
•A beep sounds.
•To continue storing other items, repeat from step 2.
•To exit the programming mode, press **OFF**.

```
Tom Jones
098-765-4321
```

- If a pause is required for dialing, **REDIAL/PAUSE** can be stored in a phone number counting as one digit (p. 52) in step 5.
- You can exit the programming mode any time by pressing **OFF**.
- If the display shows “Directory full” in step 2, the display will return to step 1, press **OFF** to exit the programming mode. To erase other stored items from the directory, see page 45.
- If an alarm tone sounds in step 7, the item cannot be stored in the directory. Place the handset on the base unit and try again from step 1.

Entering Names and Symbols

The handset dialing buttons (0 to 9), ◀ and ▶ can be used to enter letters and symbols. The letters are printed on the dialing buttons. Pressing each button selects a character as shown below.

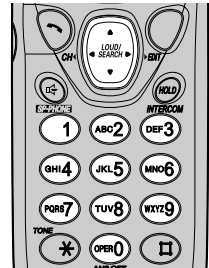

Keys	Number of times key is pressed										
	1	2	3	4	5	6	7	8	9	10	11
1	#	&	'	()	*	,	-	.	/	1
2	a	b	c	A	B	C	2				
3	d	e	f	D	E	F	3				
4	g	h	i	G	H	I	4				
5	j	k	l	J	K	L	5				
6	m	n	o	M	N	O	6				
7	p	q	r	s	P	Q	R	S	7		
8	t	u	v	T	U	V	8				
9	w	x	y	z	W	X	Y	Z	9		
0	0	Blank									
◀	To move the cursor to the left										
▶	To move the cursor to the right										

•To enter another character using the same dialing button, press ▶ to move the cursor to the next space.

If you make a mistake while entering a name

Use ◀ or ▶ to move the cursor to the incorrect character, press **CLEAR** to delete and enter the correct character. Each time you press **CLEAR**, a character is erased. To erase all characters, press and hold **CLEAR**.



For example, to enter “Tom Jones”:

- | | | |
|----|-----------------------------------------------------------------------------------------------------------|----------------------------------------------------------------|
| 1 | Press [FUNCTION] . | -----
▶Save directory
Ringer volume |
| 2 | Press [▶] at “Save directory”. | Directory=
20 items |
| 3 | Press [8] four times. | Enter name
█
◀▶ ▼=Next |
| 4 | Press [6] three times, then press [▶] to move the cursor to the right. | T |
| 5 | Press [6] . | To █ |
| 6 | Press [▶] twice to enter a blank. | Tom █ |
| 7 | Press [5] four times. | Tom J |
| 8 | Press [6] three times, then press [▶] to move the cursor to the right. | Tom Jo █ |
| 9 | Press [6] twice. | Tom Jon |
| 10 | Press [3] twice. | Tom Jones |
| 11 | Press [7] four times. | Enter name
Tom Jones
█
▶▶ ▼=Next |
| 12 | When finished, press [▼] (Next key).
•Follow steps 5 to 7 on page 39 to complete the operation. | Enter phone no. |

•While entering names, the cursor will flash on the display.

Finding Stored Items

You can search the directory using the handset.

Make sure the unit is not being used and the handset is lifted off the base unit.

- 1 Press or to enter the directory list.

```
Directory list
▼▲
▶=Caller's list
```

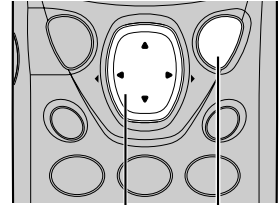

- You can go to the Caller List by pressing (p. 29).

- 2 Press or .

- The first item is displayed.

```
Ann
123-456-7890
```

- 3 Scroll to the desired caller by pressing or .

- All directory items are stored in the order shown on the right.

To search for a name by initial

- ① Press the dialing button for the first letter of the desired name until any name with the same initial is displayed (see the Index table on the page 43).
Ex. To find "Frank", press repeatedly until the first item under "F" is displayed.

- ② Press repeatedly until the name is displayed.

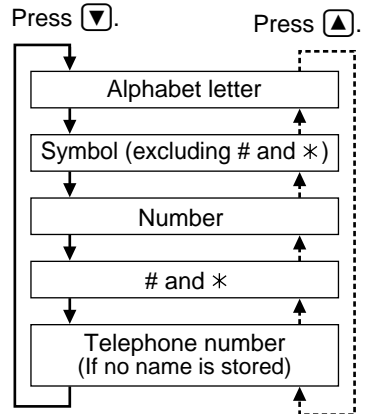

- You can exit the directory list any time by pressing .
- If "No items stored" is displayed in step 2, the directory list is empty.



Index table

Keys	Index	Keys	Index
①	Other symbols, 1	⑥	M, N, O, 6
②	A, B, C, 2	⑦	P, Q, R, S, 7
③	D, E, F, 3	⑧	T, U, V, 8
④	G, H, I, 4	⑨	W, X, Y, Z, 9
⑤	J, K, L, 5	⑩	0

Dialing

Make sure the unit is not being used and the handset is lifted off the base unit.

1 Press or to enter the directory list.

Directory list

=Caller's list

2 Press or .

- The first item is displayed.

3 Scroll to the desired item that you want to dial by pressing or .

- To search for the item by initial, see page 42.
- To exit the directory list, press **OFF**.

Frank
 456-7890

4 Press or .

- The number is dialed automatically.

Ex. was pressed.

Talk
 4567890

5 To hang up, press **OFF** or place the handset on the base unit.

- You can exit the directory list any time by pressing **OFF**.

➔ Directory

Editing

Make sure the unit is not being used and the handset is lifted off the base unit.

1 Press ◀ or ▶ to enter the directory list.

2 Press ▼ or ▲.
•The first item is displayed.

3 Scroll to the directory item you want to change by pressing ▼ or ▲, and press ▶.
•To search for the item by initial, see page 42.
•If you do not need to change the name, go to step 5.

```
Jane
456-7890
```

4 Edit the name using the dialing buttons, ◀ or ▶ (p. 40), up to 15 characters.

```
Enter name
Jane
◀▶          ▼=Next
```

5 Press ▼ (Next key).

```
Enter name
Jane Walker
◀▶          ▼=Next
```

6 Add a number to the current number.
•If you do not need to change the number, press ▼ (Next key) and go to step 8.
•Each time you press **CLEAR**, a digit is erased. To erase all digits, press and hold **CLEAR**.

```
4567890
◀▶          ▼=Next
```

7 Press ▼ (Next key).
•If you want to change the storing name or number, press ▲ (Edit key) repeatedly to reach the desired display and change it.

```
12344567890
◀▶          ▼=Next
```

8 When finished, press ▶ (Save key).
•A beep sounds.
•To continue editing other items, repeat from step 3.
•To exit the directory list, press **OFF**.



```
Jane Walker
1-234-456-7890
▲=Edit    ▶=Save
```



```
Jane Walker
1-234-456-7890
```

•You can exit the directory mode any time by pressing **OFF**.



Erasing

Make sure the unit is not being used and the handset is lifted off the base unit.

1 Press  or  to enter the directory list.

2 Press  or .

- The first item is displayed.

3 Scroll to the directory item that you want to erase by pressing  or .

- To search for the item by initial, see page 42.

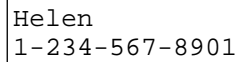

```
Helen
1-234-567-8901
```

4 Press **CLEAR**.

- To stop erasing, press  (No key).

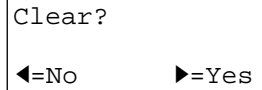

```
Clear?
←=No      →=Yes
```

5 Press  (Yes key) or **CLEAR**.

- A beep sounds and the item is erased.
- To erase other items, repeat from step 3.
- To exit the programming mode, press **OFF**.

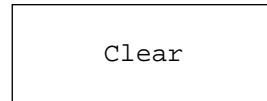

```
Clear
```

- You can exit the programming mode any time by pressing **OFF**.

Intercom

A 2-way intercom is possible between the handset and the base unit.

Paging the base unit from the handset

- 1 Handset:
Press **HOLD/INTERCOM**.
Talk to the paged party after the beeps.

- “Intercom” is displayed.

- 2 Base unit:
When the other party's voice is heard, answer using the **MIC**.

- 3 To end the intercom, press **OFF** on the handset.

OR

Press **HOLD/LOCATOR/INTERCOM** on the base unit.

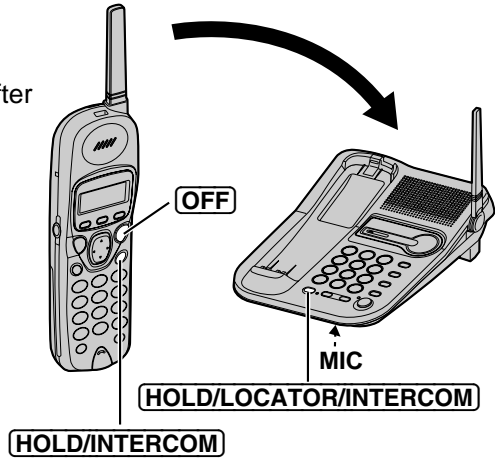

Paging the handset from the base unit (Handset locator)

Using this feature, you can also locate a misplaced handset.

- 1 Base unit:
Press **HOLD/LOCATOR/INTERCOM**.

- The handset beeps for 1 minute and displays “Paging Press INTERCOM”.

- To stop paging, press **HOLD/LOCATOR/INTERCOM** on the base unit.

- 2 Handset:
Press **HOLD/INTERCOM** to answer.

- “Intercom” is displayed.

- 3 Base unit:
Talk into the **MIC**.

- 4 To end the intercom, press **OFF** on the handset.

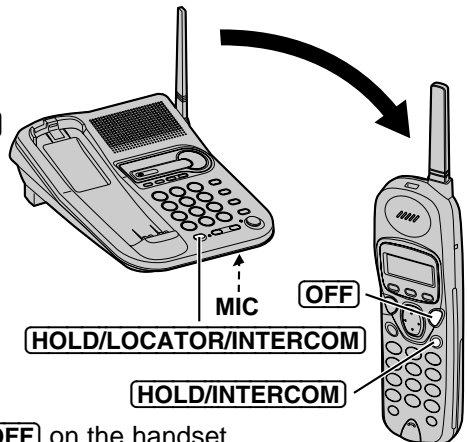

OR

Press **HOLD/LOCATOR/INTERCOM** on the base unit.



- If you do not want to answer the page in step 2, press **OFF** to stop beeping.



During an intercom call:

- If the handset user has difficulty hearing the base unit user, decrease the base unit speaker volume by pressing **VOLUME** .
- If an incoming call is received, the intercom call stops and the unit starts to ring. To answer, press ,  or **SP-PHONE**.



Transferring a Call Using the Intercom

The intercom can be used during a call. This feature enables you to transfer a call between the handset and the base unit.

From the handset to the base unit

- 1 Handset:**
During a call, press **HOLD/INTERCOM**.
 - The call is put on hold and “Hold” is displayed.
- 2 Handset:**
Press **HOLD/INTERCOM** again. Talk to the paged party after the beeps.
 - “Intercom hold” is displayed.
 - If the base unit user does not answer, press  or  to return to call.
- 3 Base unit:**
When the paging party’s voice is heard, answer using the **MIC**.
- 4 Base unit:**
To answer the call, press **SP-PHONE**.
 - The transfer is complete.

From the base unit to the handset

- 1 Base unit:**
During a call, press **HOLD/LOCATOR/INTERCOM**.
 - The call is put on hold and SP-PHONE indicator flashes.
- 2 Base unit:**
Press **HOLD/LOCATOR/INTERCOM** again.
 - “Paging Press INTERCOM” is displayed on the handset.
 - If the handset user does not answer, press **SP-PHONE** to return to call.
- 3 Handset:**
Press **HOLD/INTERCOM** to answer the page.
 - “Intercom hold” is displayed.
- 4 Handset:**
To answer the call, press  or .
 - The transfer is complete.

Voice Mail Service

Voice mail service is an electronic on-line answering system offered by your telephone company. After subscribing, the voice mail system can answer calls automatically for you when your line is busy or if calls are not answered, and caller can leave their messages at the voice mail box virtually located at the telephone company. After the voice mail box has received messages, the unit will indicate it in two ways:

(a) "Voicemail" displayed on the handset, and (b) the VM indicator on the base unit will flash.

To use this feature, you must first store your access number.

Storing a Voice Mail Access Number

Make sure the unit is not being used and the handset is lifted off the base unit.

1 Press **FUNCTION**.

2 Scroll to "Program" by pressing **▼** or **▲**.

```
Ringer pattern
▶Program
-----
```

3 Press **▶**.

4 Scroll to "Save mailbox#" by pressing **▼** or **▲**.

```
Set flash time
▶Save mailbox#
Voicemail tone
```

5 Press **▶**.

6 Enter your access number, up to 32 digits.

- You may enter pauses*(see page 49).
- Each time you press **CLEAR**, a digit is erased. To erase all digits, press and hold **CLEAR**.

```
1234567PPP890 █
◀▶           ▼=Next
```

7 Press **▼** (Next key).

- If you want to edit the entered number, press **▲** (Edit key) and return to step 6.

```
1234567PPP890
▲=Edit   ▶=Save
```

8 Press **▶** (Save key).

- A beep sounds.
- To exit the programming mode, press **OFF**.

```
1234567PPP890
Save mailbox#
```

•You can exit the programming mode any time by pressing **OFF**.

To erase a stored number

Repeat steps 1 through 5 → Press and hold **CLEAR** until all of the digits are erased → **▼** (Next key) → **▶** (Save key).

•A beep sounds.





*For quick access to your voice mail box by using **FLASH/CALL WAIT/VOICE MAIL** or **VM**, you may add pauses between your voice mail box access number and your mail box password in step 6.

EX. 1-222-333-4444 PPPP 8888

Your voice mail box access number | Pauses | Your mail box password

Pressing **REDIAL/PAUSE** once creates a 3.5 seconds delay and counts as one digit. The delay time depends on a telephone company.

Setting the Voice Mail Tone

Your telephone company sends special signals (Voice mail tones) to activate the VM indicator. Press ,  or **SP-PHONE** to listen to the dial tone. If you hear a series of dial tones followed by a continuous dial tone, this is indication that a new message was recorded. Your phone comes set to detect these tones (set to "On"). Minutes after you hang up or after the phone stops ringing, your unit will seize the phone line and check if a message has been recorded. If a new message was recorded at your telephone company, "Voicemail" will be displayed on the handset and the base unit VM indicator will flash.



Set this programming to "Off" when:

- you do not subscribe to a voice mail service,
- your telephone company does not send a series of tones, followed by a continuous tone, or
- your phone is connected to a business or office telephone system (PBX).



Please refer to below to set this programming to OFF.

If you are not sure which setting is required, consult your local telephone company or contact Panasonic Customer Call Center.



Make sure the unit is not being used and the handset is lifted off the base unit.

1 Press **FUNCTION**, and scroll to "Program" by pressing  or , and press .

Ringer pattern
▶Program

2 Scroll to "Voicemail tone" by pressing  or , and press .

Save mailbox#
▶Voicemail tone
Set line mode

3 Select "On" or "Off" by pressing  or .

Voicemail tone
:On
▼▲ ▶=Save

4 Press  (Save key).

- A beep sounds.
- To exit the programming mode, press **OFF**.



•You can exit the programming mode any time by pressing **OFF**.

Voice Mail Service

Listening to Voice Mail Messages

After the voice mail box has received messages, the unit will indicate it in two ways: (a) “Voicemail” displayed on the handset, and (b) the VM indicator on the base unit will flash. To listen to your voice mail message(s), follow the steps below.

Handset

- 1 Press **FLASH/CALL WAIT/VOICE MAIL**, and press  or .
 - The unit is connected to the telephone line and dials the access number (p. 48).
- 2 Follow the pre-recorded instructions.
- 3 When finished, press **OFF**.

Base unit

- 1 Press **VM**.
 - The unit is connected to the telephone line and dials the access number (p. 48).
- 2 Follow the pre-recorded instructions.
- 3 When finished, press **SP-PHONE**.

- If “Voicemail” still remains on the display or the VM indicator still flashes even if you have listened to your voice mail message(s), press **FUNCTION**, and press and hold **CLEAR** until the unit beeps. “Voicemail” will disappear and the VM indicator will turn off.
- If your voice mail service uses a voice mail tone and the recorded message is over 3 minutes long, “Voicemail” may not be displayed and the VM indicator may not flash.
- If your voice mail service uses a voice mail tone, the tone will be heard from any parallel connected phone. If you use another phone to retrieve messages, you have to dial your access number manually.

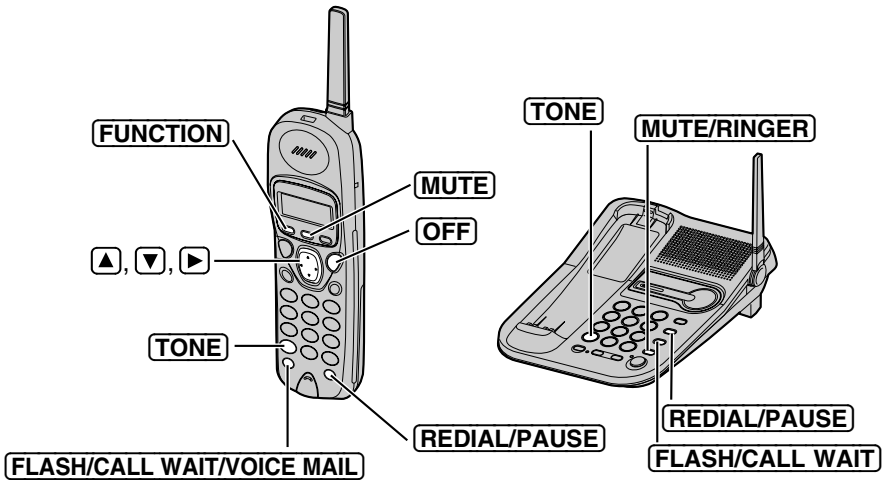

Automatic Security Code Setting

Each time you place the handset on the base unit, the unit automatically selects one of more than a million security codes. These codes help prevent the unauthorized use of your telephone line by another cordless telephone user.

Temporary Tone Dialing (For Rotary or Pulse Service Users)

Press **TONE** before entering access numbers which require tone dialing.

- The dialing mode changes to tone. You can enter numbers to access an answering service, electronic banking service, etc. When you hang up, the mode will return to pulse.

Muting Your Conversation

Handset:

Press **MUTE** while talking.

- The display on the right will be shown.

Ex. **MUTE** was pressed.

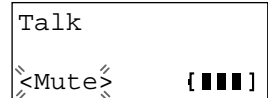

Base unit:

Press **MUTE/RINGER** while talking.

- The SP-PHONE indicator flashes.
- The other party cannot hear your voice but you can hear theirs.
- To release the mute, press **MUTE**, or on the handset or **MUTE/RINGER** or **SP-PHONE** on the base unit.

➡ Special Features

For Call Waiting Service Users

Press **FLASH/CALL WAIT/VOICE MAIL** or **FLASH/CALL WAIT** if you hear a call-waiting tone while talking.

- The first call is put on hold and you can answer the second call.
- To return to the first caller, press **FLASH/CALL WAIT/VOICE MAIL** or **FLASH/CALL WAIT** again.
- The call waiting service cannot be used when a parallel connected telephone is in use.
- If this function does not operate properly, consult your telephone company for details.

Call Waiting Caller ID Feature

Call Waiting Caller ID Feature allows your handset to display the second caller's information. After you hear a call-waiting tone while talking, the handset will display the caller's name with the phone number and "----Waiting----".

BROWN, NANCY 1-555-666-7777 ----Waiting----

- Please contact your telephone company for details and availability in your area.
- While talking with the base unit, the handset off the base unit will not display the caller's information.

How to Use the PAUSE Button (For Analog PBX Line/Long Distance Service Users)

We recommend you press **REDIAL/PAUSE** if a pause is required for dialing with a PBX or to access a long distance service.

Ex. Line access number **9** (PBX)

9 → **REDIAL/PAUSE** → Phone number

- Pressing **REDIAL/PAUSE** once creates a 3.5 second pause. This prevents misdialing when you redial or dial a stored number.
- Pressing **REDIAL/PAUSE** more than once increases the length of the pause between numbers.

FLASH Button

Pressing **FLASH/CALL WAIT/VOICE MAIL** or **FLASH/CALL WAIT** allows you to use special features of your host PBX such as transferring an extension call or accessing special telephone services (optional) such as call waiting.

- Pressing **FLASH/CALL WAIT/VOICE MAIL** or **FLASH/CALL WAIT** causes to release following operations:
 - temporary tone dialing, or
 - muting your conversation.

Selecting the flash time

The flash time depends on your telephone exchange or host PBX. You can select the following flash times: “700, 600, 400, 300, 250, 110, 100 or 90 ms (milliseconds)”. Your phone comes from the factory set to “700 ms”.

Make sure the unit is not being used and the handset is lifted off the base unit.

- 1 Press **FUNCTION**.
- 2 Scroll to “Program” by pressing **▼** or **▲**.
- 3 Press **▶**.
- 4 Press **▶** at “Set flash time”.
 - The current setting is displayed.
- 5 Select the desired time by pressing **▼** or **▲**.
- 6 Press **▶** (Save key) .
 - A beep sounds.
 - To exit the programming mode, press **OFF**.

```
Ringer pattern
▶Program
-----
```

```
-----
▶Set flash time
Save mailbox#
```

```
Flash time
: 700ms
▼▲ ▶=Save
```

- You can exit the programming mode any time by pressing **OFF**.
- If the unit is connected via a PBX, PBX functions (transferring a call etc.) might not work correctly. Consult your PBX supplier for the correct setting.

Wall Mounting

This unit can be mounted on a wall phone plate.

- 1 Push the hook and turn it around.
Turn the hook until a click is heard.

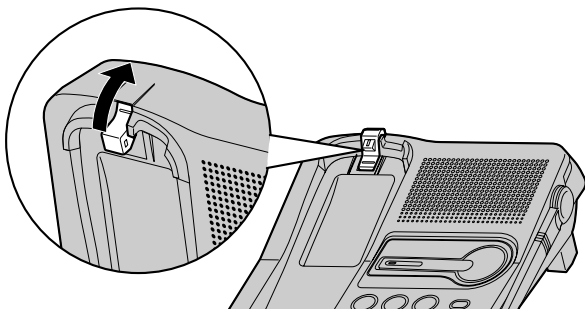

- 2 Connect the AC adaptor.

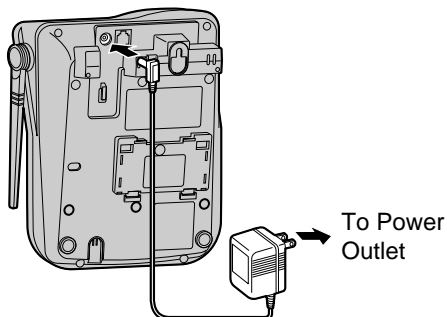

- 3 Tuck the telephone line cord inside the wall mounting adaptor, then push it in the direction of the arrow.
 - The word "UP" should face upward.

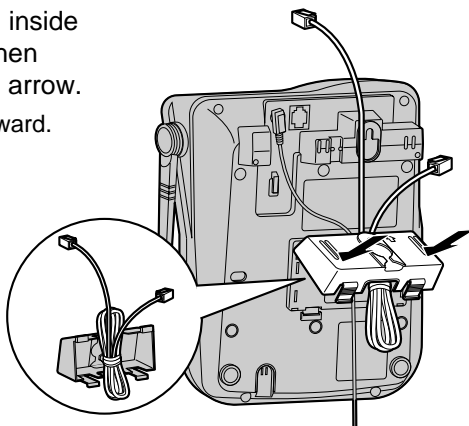

4 Connect the telephone line cord.
Mount the unit, then slide down.

- Raise the antenna.
- Fasten the telephone line cord to prevent it from being disconnected.

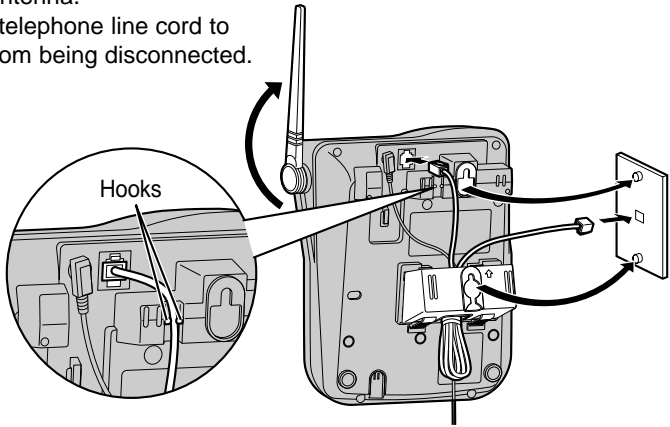

5 **To charge the handset battery:**
Fix the charge contacts (①) and insert
the hook to the handset hole (②).

- The IN USE/CHARGE indicator lights.

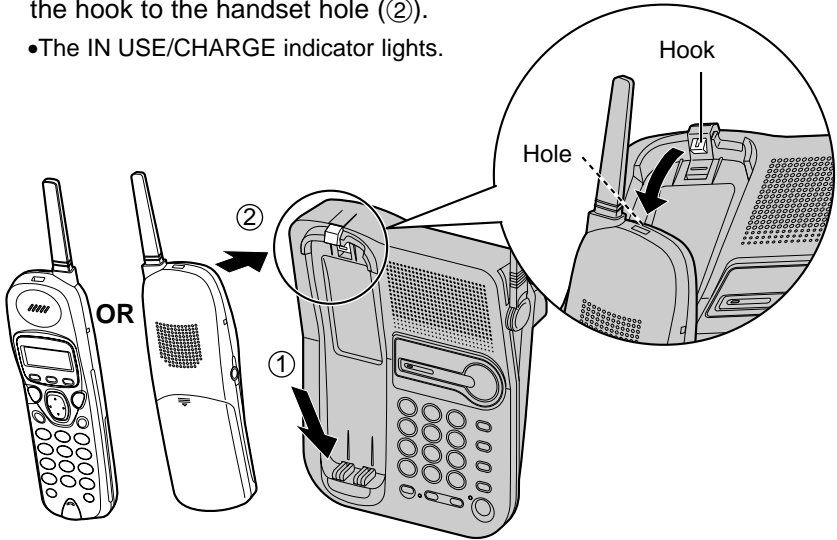

Belt Clip

You can hang the handset on your belt or pocket using the belt clip.

To attach the belt clip

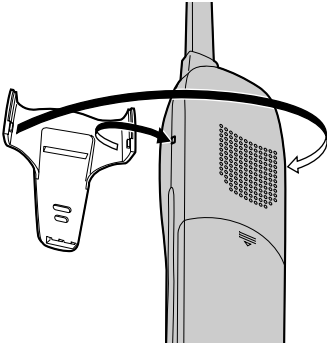

To remove the belt clip





Optional Headset

Plugging an optional headset into the handset allows a hands-free phone conversation. Please use only a Panasonic KX-TCA88 or KX-TCA90 headset. To order, call the accessories telephone number on page 2.

Connecting an optional headset to the handset

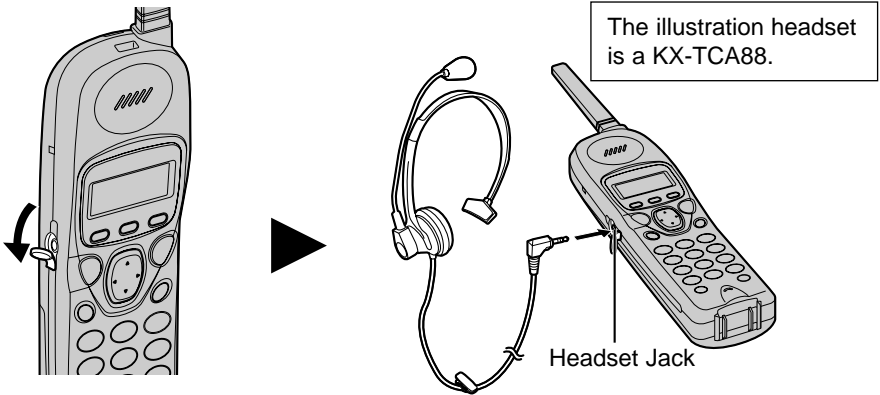
Open the headset jack cover, and connect an optional headset to the headset jack as shown below.



To switch to the speakerphone while using the headset:
Press . To return to the headset, press .

Battery Replacement

If “Recharge” is displayed and/or “[■]” flashes after being fully charged, replace the battery with a new Panasonic N4HKGMA00001 (P-P511) battery. To order, call the accessories telephone number on page 2.

- 1 Press the notch on the handset cover firmly and slide it as indicated by the arrow.



- 2 Remove the old battery. Insert the new battery into the handset as shown (1), matching the correct polarity. Press the battery down until it places into the compartment (2).

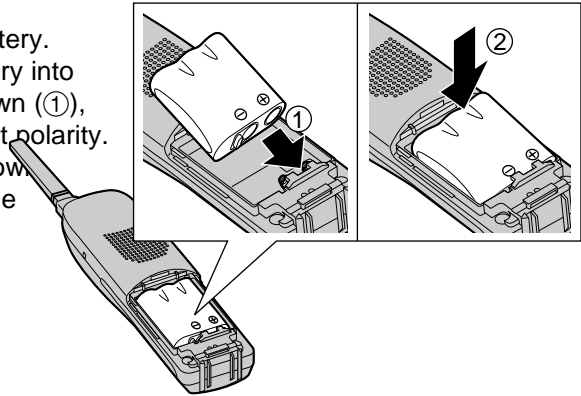

- 3 Close the cover. Make sure you charge the new battery for about 15 hours in order to display the battery strength prompt correctly

A nickel cadmium battery that is recyclable powers the product you have purchased. At the end of its useful life, under various state and local laws, it is illegal to dispose of this battery into your municipal waste stream. Please call 1-800-8-BATTERY for information on how to recycle this battery.



Adding Another Phone



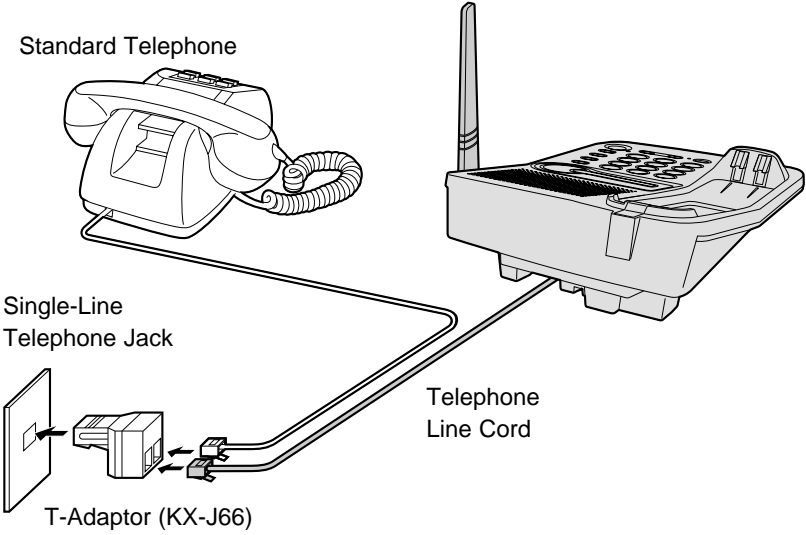



This unit will not function during a power failure. To connect a standard telephone on the same line, use the Panasonic T-adaptor KX-J66. To order, call the accessories telephone number on page 2.





Problem	Remedy
The unit does not work.	<ul style="list-style-type: none">•Check the settings (p. 11–15).•Charge the battery fully (p. 12).•Clean the charge contacts and charge again (p. 13).•Install the battery properly (p. 12).•Place the handset on the base unit and unplug the AC adaptor to reset. Plug in, and try again.•Re-install the battery and place the handset on the base unit (p. 57). Try again.
☎	<ul style="list-style-type: none">•You are too far from the base unit. Move closer and try again.•Place the handset on the base unit and try again.•Plug in the AC adaptor.•Raise the base unit antenna. <hr/> <ul style="list-style-type: none">•Locate the handset and the base unit away from other electrical appliances (p. 3).•Move closer to the base unit.•Raise the base unit antenna.•Press  to select a clearer channel in the talk, speakerphone or intercom mode. <hr/> <ul style="list-style-type: none">•The ringer volume is set to OFF. Set to HIGH or LOW (p. 18).•When the handset is on the base unit, the handset does not ring. Only the base unit rings in the selected pattern when receiving a call. <hr/> <ul style="list-style-type: none">•Charge the battery fully (p. 12).



➔ Troubleshooting

Problem	Remedy
You cannot program items, such as the dialing mode.	<ul style="list-style-type: none">• Programming is not possible while the unit is in the talk or speakerphone mode, when viewing the Caller List/directory list.• Do not pause for over 60 seconds while programming.• Move closer to the base unit.• , ,  or  may have been pressed when you picked up the handset. Press OFF and try again.
Previously programmed information is erased.	<ul style="list-style-type: none">• If a power failure occurs, programmed information may be erased. Reprogram if necessary.
You cannot store a name and phone number in the directory.	<ul style="list-style-type: none">• You cannot store an item in the directory while the unit is in the talk, speaker or intercom mode or while storing phone numbers in the base unit.• Do not pause for over 60 seconds while storing.
While programming or searching, the unit starts to ring and stops the program/search.	<ul style="list-style-type: none">• To answer the call, press ,  or SP-PHONE. Start again from the beginning after hanging up.
The unit does not display the caller's name and/or phone number.	<ul style="list-style-type: none">• You need to subscribe to a Caller ID service.• Other telephone equipment may be interfering with your phone. Disconnect it and try again.• Other electrical appliances connected to the same outlet may be interfering with the Caller ID information.• Telephone line noise may be affecting the Caller ID information.



Problem	Remedy
The handset display exits the Caller List.	<ul style="list-style-type: none">•Do not pause for over 60 seconds while searching.
When a second call is received during a conversation, the unit does not display the new caller's name and/or phone number.	<ul style="list-style-type: none">•The line mode selection is incorrect. See page 15.•The caller requested not to send his/her information. See page 28.
You cannot page the handset.	<ul style="list-style-type: none">•The handset is too far from the base unit.•The handset is engaged in an outside call, viewing the Caller List/directory list. Wait until the IN USE/CHARGE indicator light goes out.
You cannot redial by pressing REDIAL/PAUSE .	<ul style="list-style-type: none">•If the last number dialed was more than 32 digits long, the number will not be redialed correctly.•The button has a double function as either redial or pause. It will redial the last number dialed if pressed at the outset of a call (p. 22, 26). If another number has been dialed first, it will operate as a pause button (p. 52).
“ Ⓡ ”	<ul style="list-style-type: none">•Charge the battery fully (p. 12).
	<ul style="list-style-type: none">•Clean the charge contacts and charge again (p. 13).•Install a new battery (p. 57).
	<ul style="list-style-type: none">•This is normal.

➔ Troubleshooting

Problem	Remedy
You cannot have a conversation using the headset.	<ul style="list-style-type: none"> • Make sure that an optional headset is connected properly (p. 56). •  may have been pressed.
If you cannot solve your problem	<p>If “S P - P h o n e” is displayed on the handset, press  to continue the conversation with the headset.</p> <ul style="list-style-type: none"> • Call our customer call center at

Important Safety Instructions



When using this unit, basic safety precautions should always be followed to reduce the risk of fire, electric shock, or personal injury.

1. Read and understand all instructions.
2. Follow all warnings and instructions marked on this unit.
3. Unplug this unit from AC outlets before cleaning. Do not use liquid or aerosol cleaners. Use a damp cloth for cleaning.
4. Do not use this unit near water, for example, near a bathtub, washbowl, kitchen sink, or the like.
5. Place this unit securely on a stable surface. Serious damage and/or injury may result if the unit falls.
6. Do not cover slots and openings on the unit. They are provided for ventilation and protection against overheating. Never place the unit near radiators, or in a place where proper ventilation is not provided.
7. Use only the power source marked on the unit. If you are not sure of the type of power supplied to your home, consult your dealer or local power company.
8. Do not place objects on the power cord. Install the unit where no one can step or trip on the cord.
9. Do not overload wall outlets and extension cords. This can result in the risk of fire or electric shock.
10. Never push any objects through slots in this unit. This may result in the risk of fire or electric shock. Never spill any liquid on the unit.
11. To reduce the risk of electric shock, do not disassemble this unit. Take the unit to an authorized servicer when service is required. Opening or removing covers may expose you to dangerous voltages or other risks. Incorrect reassembly can cause electric shock when the unit is subsequently used.
12. Unplug this unit from the wall outlet and refer servicing to an authorized servicer when the following conditions occur:
 - A. When the power supply cord or plug is damaged or frayed.
 - B. If liquid has been spilled into the unit.
 - C. If the unit has been exposed to rain or water.
 - D. If the unit does not work normally by following the operating instructions. Adjust only controls covered by the operating instructions. Improper adjustment may require extensive work by an authorized servicer.
 - E. If the unit has been dropped or physically damaged.
 - F. If the unit exhibits a distinct change in performance.
13. During thunderstorms, avoid using telephones except cordless types. There may be a remote risk of an electric shock from lightning.
14. Do not use this unit to report a gas leak, when in the vicinity of the leak.

SAVE THESE INSTRUCTIONS

For assistance, please call: 1-800-211-PANA(7262)

Important Safety Instructions

CAUTION:

To reduce the risk of fire or injury to persons, read and follow these instructions.

1. Use only the battery(ies) specified.
2. Do not dispose of the battery(ies) in a fire. They may explode. Check with local waste management codes for special disposal instructions.
3. Do not open or mutilate the battery(ies). Released electrolyte is corrosive and may cause burns or injury to the eyes or skin. The electrolyte may be toxic if swallowed.
4. Exercise care in handling batteries in order not to short the battery to conductive materials such as rings, bracelets, and keys. The battery and/or conductor may overheat and cause burns.
5. Charge the battery(ies) provided with or identified for use with this product only in accordance with the instructions and limitations specified in this manual.

WARNING:

TO PREVENT FIRE OR SHOCK HAZARD, DO NOT EXPOSE THIS PRODUCT TO RAIN OR ANY TYPE OF MOISTURE.

- The AC adaptor is used as the main disconnect device, ensure that the AC outlet is located/installed near the unit and is easily accessible.

FCC and Other Information

This equipment complies with Part 68 of the FCC rules and the requirements adopted by the ACTA. On the bottom of this equipment is a label that contains, among other information, a product identifier in the format US:ACJ-----.

If requested, this number must be provided to the telephone company.

Registration No.(found on the bottom of the unit)

Ringer Equivalence No. (REN).....0.1B

A plug and jack used to connect this equipment to the premises wiring and telephone network must comply with the applicable FCC Part 68 rules and requirements adopted by the ACTA. A compliant telephone cord and modular plug is provided with this product. It is designed to be connected to a compatible modular jack that is also compliant.

The REN is used to determine the number of devices that may be connected to a telephone line. Excessive RENs on a telephone line may result in the devices not ringing in response to an incoming call. In most but not all areas, the sum of RENs should not exceed five (5.0). To be certain of the number of devices that may be connected to a line, as determined by the total RENs, contact the local telephone company. For products approved after July 23, 2001, the REN for this product is part of the product identifier that has the format US:AAAEQ##TXXXX. The digits represented by ## are the REN without a decimal point (e.g., 03 is a REN of 0.3).



If this equipment causes harm to the telephone network, the telephone company will notify you in advance that temporary discontinuance of service may be required. But if advance notice isn't practical, the telephone company will notify the customer as soon as possible. Also, you will be advised of your right to file a complaint with the FCC if you believe it is necessary.

The telephone company may make changes in its facilities, equipment, operations or procedures that could affect the operation of the equipment. If this happens the telephone company will provide advance notice in order for you to make necessary modifications to maintain uninterrupted service.

If trouble is experienced with this equipment, for repair or warranty information, please contact a Factory Servicenter or other Authorized Servicer. If the equipment is causing harm to the telephone network, the telephone company may request that you disconnect the equipment until the problem is resolved.

Connection to party line service is subject to state tariffs. Contact the state public utility commission, public service commission or corporation commission for information.

If your home has specially wired alarm equipment connected to the telephone line, ensure the installation of this equipment does not disable your alarm equipment. If you have questions about what will disable alarm equipment, consult your telephone company or a qualified installer.

WHEN PROGRAMMING EMERGENCY NUMBERS AND(OR) MAKING TEST CALLS TO EMERGENCY NUMBERS:

- 1) Remain on the line and briefly explain to the dispatcher the reason for the call.
- 2) Perform such activities in the off-peak hours, such as early morning or late evenings.

This device complies with Part 15 of the FCC Rules. Operation is subject to the following two conditions: (1) This device may not cause harmful interference, and (2) this device must accept any interference received, including interference that may cause undesired operation.

Privacy of communications may not be ensured when using this phone.

CAUTION:

Any changes or modifications not expressly approved by the party responsible for compliance could void the user's authority to operate this device.

Note:

This equipment has been tested and found to comply with the limits for a Class B digital device, pursuant to Part 15 of the FCC Rules. These limits are designed to provide reasonable protection against harmful interference in a residential installation. This equipment generates, uses, and can radiate radio frequency energy and, if not installed and used in accordance with the instructions, may cause harmful interference to radio communications. However, there is no guarantee that interference will not occur in a particular installation. If this equipment does cause harmful interference to radio or television reception, which can be determined by turning the equipment off and on, the user is encouraged to try to correct the interference by one or more of the following measures:

- Reorient or relocate the receiving antenna.
- Increase the separation between the equipment and receiver.
- Connect the equipment into an outlet on a circuit different from that to which the receiver is connected.
- Consult the dealer or an experienced radio/TV technician for help.

➔ FCC and Other Information

Some cordless telephones operate at frequencies that may cause interference to nearby TVs and VCRs. To minimize or prevent such interference, the base of the cordless telephone should not be placed near or on top of a TV or VCR. If interference is experienced, move the cordless telephone further away from the TV or VCR. This will often reduce, or eliminate, interference.

Operating near 2.4GHz electrical appliances may cause interference. Move away from the electrical appliances and/or press the CH (Channel) button.

CAUTION:

To comply with FCC RF exposure requirements, the base unit should be installed with its antenna located at 20 cm or more from persons and handset should be carried with the specific belt-clip provided for the handset to ensure compliance. Other non-tested belt-clips or similar body-worn accessories may not comply, therefore, should be avoided.

This equipment is hearing aid compatible as defined by the FCC in 47 CFR Section 68.316.

When you hold the phone to your ear, noise might be heard in your Hearing Aid. Some Hearing Aids are not adequately shielded from external RF (radio frequency) energy. If noise occurs, use an optional headset accessory or the speakerphone option (if applicable) when using this phone. Consult with your audiologist or Hearing Aid manufacturer about the availability of Hearing Aids which provide adequate shielding to RF energy commonly emitted by digital devices.

- **Environment** — do not place the unit in a room where the temperature is less than 5°C (41°F) or greater than 40°C (104°F). Allow 10 cm (4") clearance around the unit for proper ventilation. Avoid excessive smoke, dust, mechanical vibration, shock, or direct sunlight.
- **Medical** — consult the manufacturer of any personal medical devices, such as pacemakers or hearing aids, to determine if they are adequately shielded from external RF (radio frequency) energy. (The unit operates in the frequency range of 2402MHz to 2480MHz, and the power output level can range 0.015 watts.) Do not use the unit in health care facilities if any regulations posted in the area instruct you not to do so. Hospitals or health care facilities may be using equipment that could be sensitive to external RF (radio frequency) energy.
- **Routine care** — wipe the unit with a soft cloth. Do not use benzine, thinner, or any abrasive powder. When you leave the unit unused for a long period of time, unplug the AC adaptor from the outlet.
- **If there is any trouble** — disconnect the unit from the telephone line and connect a known working phone. If the known working phone operates properly, have your unit repaired by a Factory Servicenter or other Authorized Servicer. If the known working phone does not operate properly, consult your telephone company.

Specifications

■ Base unit

Power Supply:	AC Adaptor (120 V AC, 60 Hz)
Power Consumption:	Standby: Approx. 3.2 W Maximum: Approx. 5 W
Frequency:	2.41 GHz – 2.48 GHz
Dimensions (H x W x D):	Approx. 84 mm x 180 mm x 215 mm (3 ⁵ / ₁₆ " x 7 ³ / ₃₂ " x 8 ¹⁵ / ₃₂ ")
Mass (Weight):	Approx. 470 g (1.04 lb.)

■ Handset

Power Supply:	Ni-Cd battery (3.6 V, 850 mAh)
Frequency:	2.41 GHz – 2.48 GHz
Dimensions (H x W x D):	Approx. 245 mm x 55 mm x 45 mm (9 ³ / ₃₂ " x 2 ⁵ / ₃₂ " x 1 ²⁵ / ₃₂ ")
Mass (Weight):	Approx. 230 g (0.51 lb.)
Security Codes:	1,000,000

■ **Dialing Mode:** Tone (DTMF)/Pulse

■ **Operating Environment:** 5 °C – 40 °C (41 °F – 104 °F)

Specifications are subject to change without notice.

Index

- A** Accessories 2
 - Answering calls 27
 - Auto talk 17, 27
 - Automatic Security Code Setting . 51
- B** Backlit LCD 24
 - Base location..... 3
 - Battery, Charge 3, 12
 - Battery information 13
 - Battery replacement 57
 - Battery strength 13
 - Belt Clip 56
- C** Call on hold 23, 26
 - Call waiting caller ID 52
 - Call waiting tone 52
 - Caller ID Auto edit feature..... 32, 33
 - Caller ID service..... 28, 52
 - Caller List
 - editing..... 32
 - erasing 35
 - storing 34
 - viewing 29, 30
 - Calling back from Caller ID List... 31
- D** Dialing mode 14
 - Directory 38
 - dialing 43
 - editing..... 44
 - erasing 45
 - finding..... 42
 - name and symbols 40
 - storing 38
 - Display 8
- F** FCC and other information..... 64
 - FLASH button..... 53
 - Flash time..... 53
 - Function Menu 16
- H** Headset, optional 56
 - Hold alarm 23, 26
- I** Installation
 - AC adaptor 11
 - Adding another phone..... 58
 - Battery 12
 - Telephone line cord 11
 - Intercom call 46
 - Intercom paging 46
- L** LCD contrast 20
 - Lighted Handset Keypad..... 24
 - Line mode 15
 - Location of controls 6, 7
- M** Making Calls
 - Base Unit 25
 - Handset..... 21, 22
 - Microphone
 - Base Unit 25, 46
 - Handset..... 22
 - Muting a conversation 51
- N** Noise 3
- P** PAUSE 52
 - Pulse service 51
- R** Redial 22, 26
 - Redial list..... 23
 - Ringer Off 18
 - Ringer Pattern 19
 - Ringer Volume 18
 - Rotary service, tone dialing..... 51
- S** Safety Instructions..... 63
 - Shipping product for service..... 71
 - Specifications 67
 - Speed Dialer
 - Dialing 37
 - Storing 36
 - SP-phone
 - Base Unit 25
 - Handset..... 22
- T** Transferring a call 47
 - Troubleshooting 59
- V** VM (Voice Mail Service)..... 48
 - Volume control
 - Base Unit 26, 47
 - Handset..... 22, 24
- W** Wall Mounting 54
 - Warranty 69

**PANASONIC CONSUMER
ELECTRONICS COMPANY, DIVISION
OF MATSUSHITA ELECTRIC
CORPORATION OF AMERICA**
One Panasonic Way
Secaucus, New Jersey 07094

**PANASONIC SALES COMPANY,
DIVISION OF MATSUSHITA
ELECTRIC OF PUERTO RICO, INC.,**
Ave. 65 de Infanteria, Km. 9.5
San Gabriel Industrial Park
Carolina, Puerto Rico 00985

Panasonic Telephone Products Limited Warranty

Limited Warranty Coverage

If your product does not work properly because of a defect in materials or workmanship, Panasonic Consumer Electronics Company or Panasonic Sales Company (collectively referred to as "the warrantor") will, for the length of the period indicated on the chart below, which starts with the date of original purchase ("warranty period"), at its option either (a) repair your product with new or refurbished parts, or (b) replace it with a new or a refurbished product. The decision to repair or replace will be made by the warrantor.

**Parts
One (1) Year**

**Labor
One (1) Year**

During the "Labor" warranty period there will be no charge for labor. During the "Parts" warranty period, there will be no charge for parts. You must mail-in your product during the warranty period. This Limited Warranty excludes both parts and labor for batteries, antennas, and cosmetic parts (cabinet). This warranty only applies to products purchased and serviced in the United States or Puerto Rico. This warranty is extended only to the original purchaser of a new product which was not sold "as is".

Mail-In Service

For assistance in the continental U.S.A. in obtaining repairs please ship the product to:

**Panasonic Services Company
Customer Servicer
Suite B
4900 George McVay Drive
McAllen, TX 78503**

For assistance in Puerto Rico call Panasonic Sales Company (787)-750-4300 or fax (787)-768-2910.

When shipping the unit carefully pack and send it prepaid, adequately insured and preferably in the original carton. Include a letter detailing the complaint and provide a day time phone number where you can be reached.

IF REPAIR IS NEEDED DURING THE WARRANTY PERIOD THE PURCHASER WILL BE REQUIRED TO FURNISH A SALES RECEIPT/PROOF OF PURCHASE INDICATING DATE OF PURCHASE, AMOUNT PAID AND PLACE OF PURCHASE. CUSTOMER WILL BE CHARGED FOR THE REPAIR OF ANY UNIT RECEIVED WITHOUT SUCH PROOF OF PURCHASE.

Limited Warranty Limits And Exclusions

This warranty ONLY COVERS failures due to defects in materials or workmanship, and DOES NOT COVER normal wear and tear or cosmetic damage. The warranty ALSO DOES NOT COVER damages which occurred in shipment, or failures which are caused by products not supplied by the warrantor, or failures which result from accidents, misuse, abuse, neglect, mishandling, misapplication, alteration, faulty installation, set-up adjustments, misadjustment of consumer controls, improper maintenance, power line surge, lightning damage, modification, introduction of sand, humidity or liquids, commercial use such as hotel, office, restaurant, or other business or rental use of the product, or service by anyone other than a Factory Servicer or other Authorized Servicer, or damage that is attributable to acts of God.

THERE ARE NO EXPRESS WARRANTIES EXCEPT AS LISTED UNDER "LIMITED WARRANTY COVERAGE". THE WARRANTOR IS NOT LIABLE FOR INCIDENTAL OR CONSEQUENTIAL DAMAGES RESULTING FROM THE USE OF THIS PRODUCT, OR ARISING OUT OF ANY BREACH OF THIS WARRANTY. (As examples, this excludes damages for lost time, lost calls or messages, cost of having someone remove or re-install an installed unit if applicable, travel to and from the servicer. The items listed are not exclusive, but are for illustration only.) **ALL EXPRESS AND IMPLIED WARRANTIES, INCLUDING THE WARRANTY OF MERCHANTABILITY, ARE LIMITED TO THE PERIOD OF THE LIMITED WARRANTY.**

Some states do not allow the exclusion or limitation of incidental or consequential damages, or limitations on how long an implied warranty lasts, so the exclusions may not apply to you.

This warranty gives you specific legal rights and you may also have other rights which vary from state to state. If a problem with this product develops during or after the warranty period, you may contact your dealer or Servicenter. If the problem is not handled to your satisfaction, then write to the warrantor's Consumer Affairs Department at the addresses listed for the warrantor.

PARTS AND SERVICE, WHICH ARE NOT COVERED BY THIS LIMITED WARRANTY, ARE YOUR RESPONSIBILITY.

Customer Services Directory

For Product Information, Operating Assistance, Literature Request, Dealer Locations, and all Customer Service inquiries please contact: 1-800-211-PANA (7262), Monday-Friday 9 am-9 pm; Saturday-Sunday 9 am-7 pm, EST. or send e-mail : consumerproducts@panasonic.com

***Web Site: <http://www.panasonic.com>
You can purchase parts, accessories or locate your nearest servicer by visiting our Web Site.***

Accessory Purchases:

**1-800-332-5368 (Customer Orders Only)
Panasonic Services Company 20421 84th Avenue South, Kent, WA 98032
(6 am to 5 pm Monday - Friday; 6 am to 10:30 am Saturday; PST)
(Visa, MasterCard, Discover Card, American Express, Check)**

***Service in Puerto Rico
Matsushita Electric of Puerto Rico, Inc. Panasonic Sales Company/
Factory Servicenter:
Ave. 65 de Infantería, Km. 9.5, San Gabriel Industrial Park,
Carolina, Puerto Rico 00985
Phone (787)750-4300 Fax (787)768-2910***

For product service

- Call 1-800-211-PANA(7262) for the location of an authorized servicer.
- Panasonic's e-mail address for customer inquiries:
consumerproducts@panasonic.com
for customers in the USA or Puerto Rico ONLY

When you ship the product

- Carefully pack your unit, preferably in the original carton.
- Attach a letter, detailing the symptom, to the outside of the carton.

Symptom

- Send the unit to an authorized servicer, prepaid and adequately insured.
- Do not send your unit to the Panasonic Consumer Electronics Company listed on the back cover or to executive or regional sales offices. These locations do not repair consumer products.

- This cordless telephone is designed for use in the United States of America. Sale or use of this product in other countries may violate local laws.
- Ce téléphone sans fil est conçu pour être utilisé aux États-Unis d'Amérique. La vente ou l'emploi de cet appareil dans certains autres pays peut constituer une infraction à la législation locale.
- Este teléfono sin cordón fue elaborado para uso en los Estados Unidos de América. La venta o el empleo de este producto en ciertos países puede constituir violación de la legislación local.
- このコードレス電話機は、日本国外での使用を目的として設計されており、日本国内での使用は法律違反となります。従って、当社では日本国内においては原則として修理などのサービスは致しかねます。

**If you need assistance with the set-up or operation,
please call 1-800-211-PANA(7262)**

**Panasonic Consumer Electronics Company,
Division of Matsushita Electric Corporation of America**
One Panasonic Way, Secaucus, New Jersey 07094

**Panasonic Sales Company,
Division of Matsushita Electric of Puerto Rico, Inc.**
Ave. 65 de Infantería, Km. 9.5, San Gabriel Industrial Park
Carolina, Puerto Rico 00985